

SIDE SPREADER SPARE PARTS BOOK



Table of Contents:

Pages 3-14: MS150 Spreader Spare Parts Lists

Pages 15-32: MS20, MS30 and MS450 Spreader Spare Parts List

Pages 33-60: MS700 and MS1000 Spare Parts List

MS150 SIDE SPREADER SPARE PARTS LIST



MS150 SPREADER PARKING JACK

BOM ID	Description	PartNo	Qty
1	PARKING JACK	P001.680	1
2	FOAM PROTECTION STRIP	P001.681	1
3	LINCH PIN	ZGPP94	1

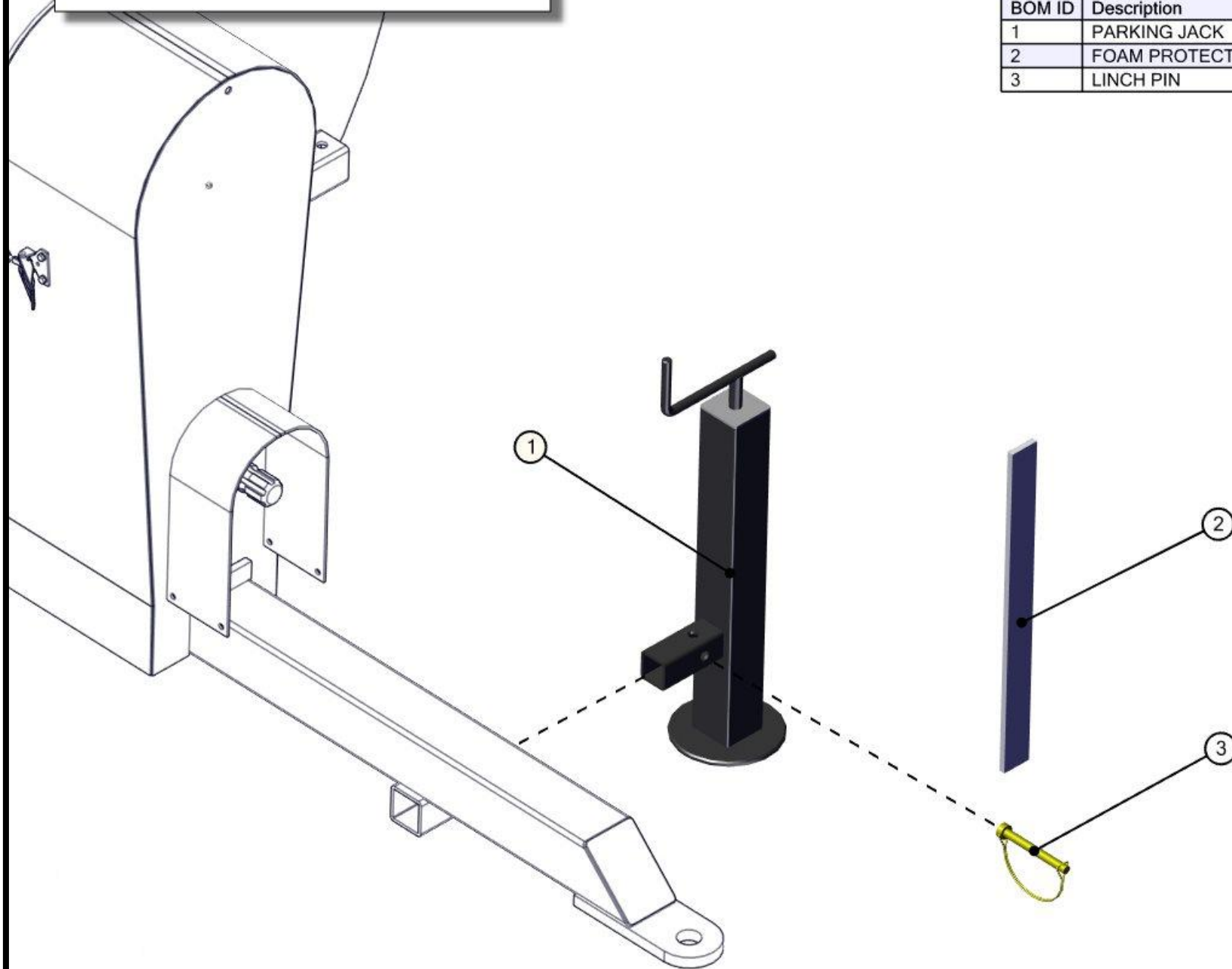

MS150 SPREADER GEARBOX COVER

BOM ID	Description	PartNo	Qty
1	MS150 EDGE TRIM	P001.688	1
2	LATCH	ZGPP211	2
3	MS150 GEARBOX GUARD	P001.682	1
4	M5x20 SETSCREW ZP	ZFAS112	4
5	M5 NYLOCK NUT ZP	ZFAS114	4
6	M5 WASHER ZP	ZFAS113	8

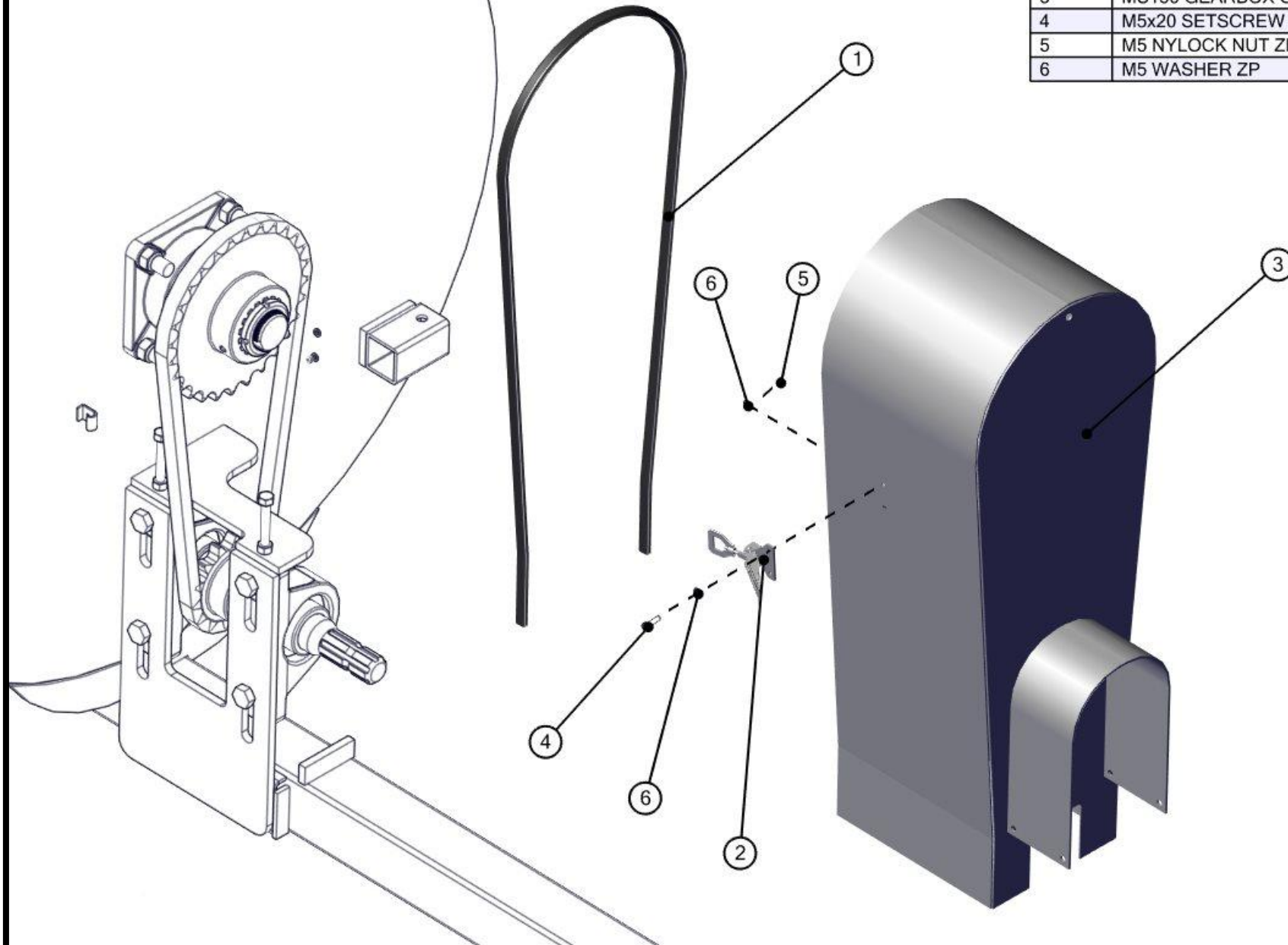

MS150 SPREADER FRONT VIEW

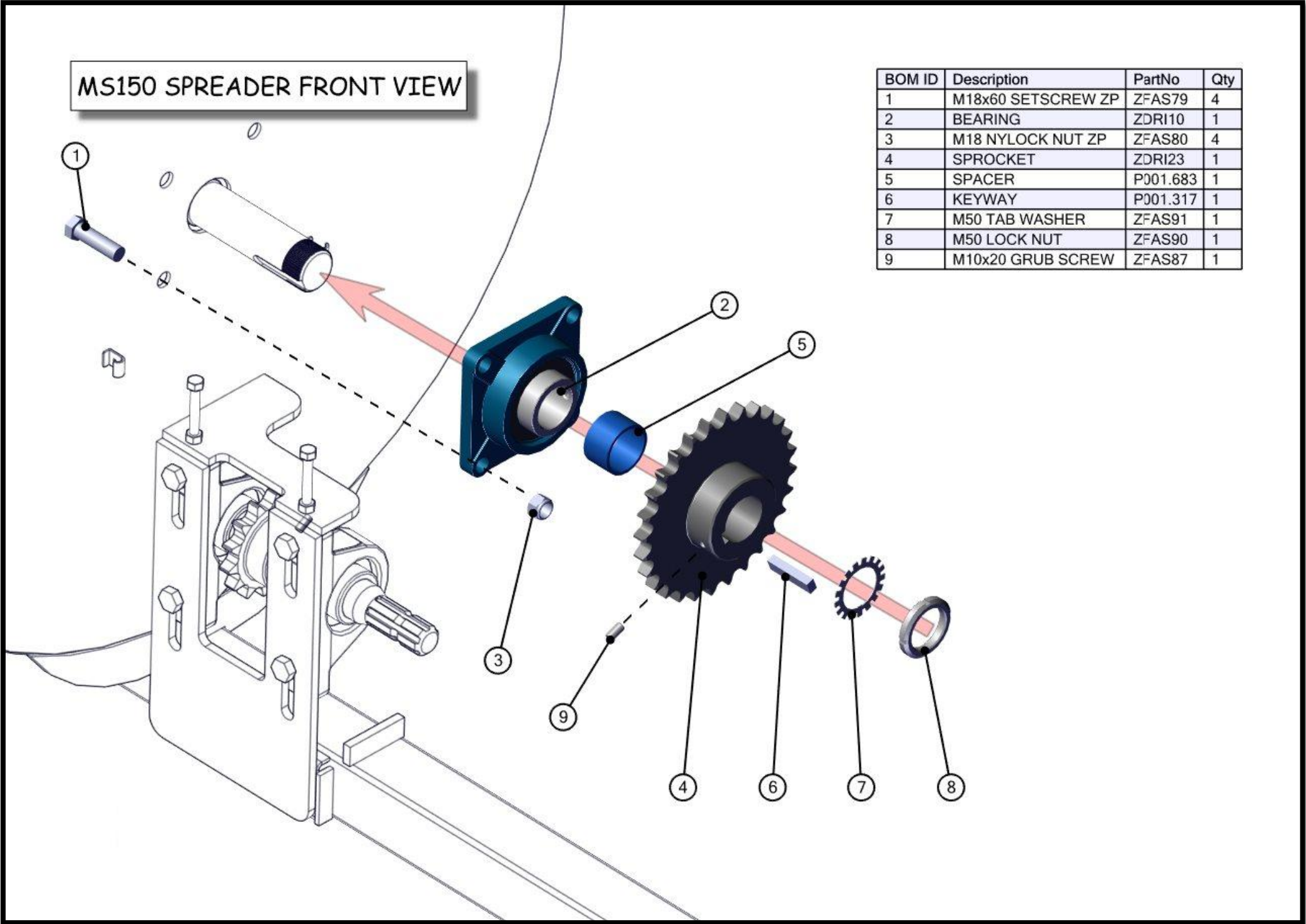

BOM ID	Description	PartNo	Qty
1	M18x60 SETSCREW ZP	ZFAS79	4
2	BEARING	ZDRI10	1
3	M18 NYLOCK NUT ZP	ZFAS80	4
4	SPROCKET	ZDRI23	1
5	SPACER	P001.683	1
6	KEYWAY	P001.317	1
7	M50 TAB WASHER	ZFAS91	1
8	M50 LOCK NUT	ZFAS90	1
9	M10x20 GRUB SCREW	ZFAS87	1

MS150 GEARBOX ASSEMBLY

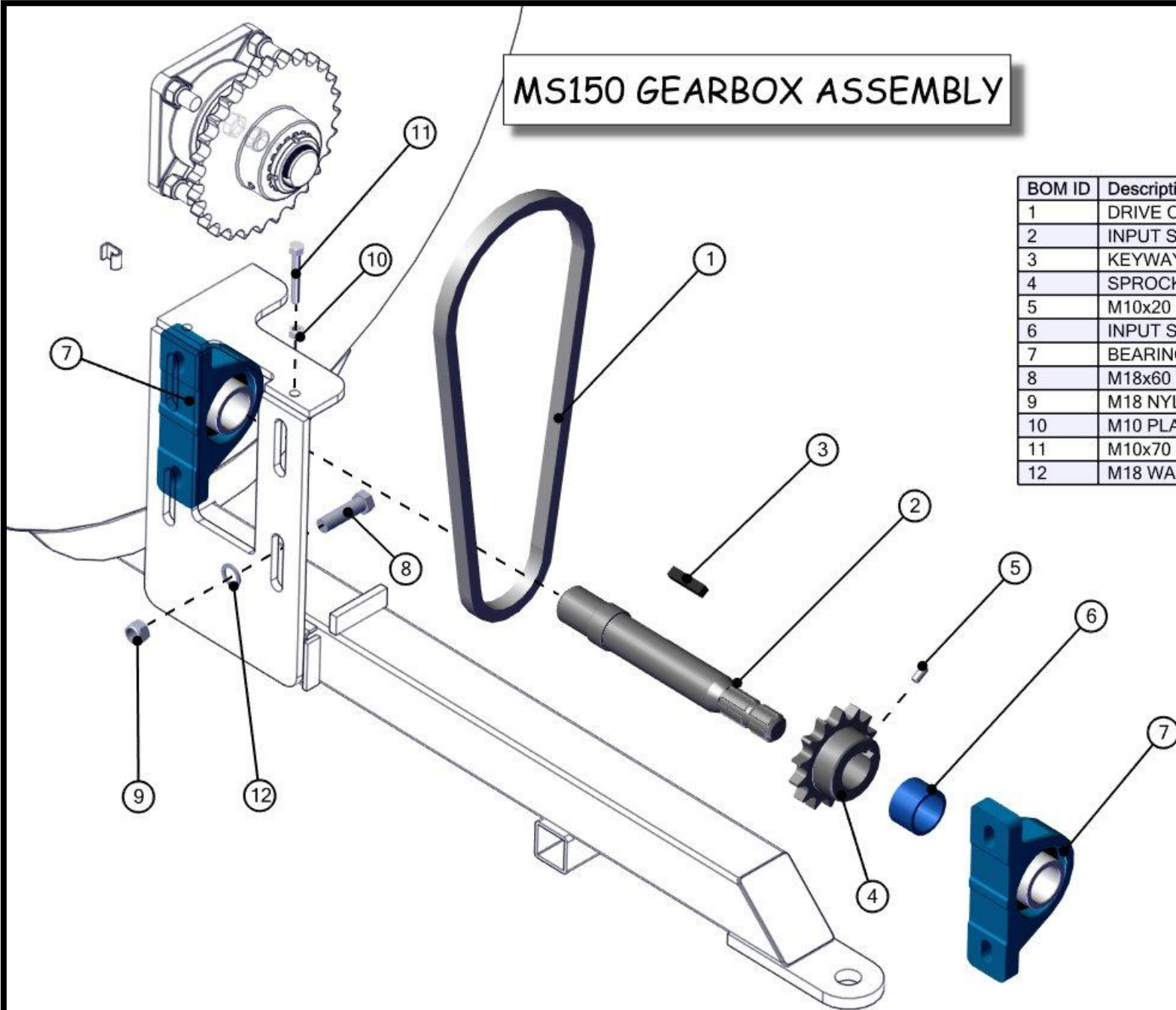

BOM ID	Description	PartNo	Qty
1	DRIVE CHAIN	ZDRI27	1
2	INPUT SHAFT	ZMAC21	1
3	KEYWAY	P001.333	1
4	SPROCKET	ZDRI13	1
5	M10x20 GRUB SCREW	ZFAS87	1
6	INPUT SHAFT SPACER	P001.684	1
7	BEARING	ZDRI24	2
8	M18x60 SETSCREW ZP	ZFAS79	4
9	M18 NYLOCK NUT ZP	ZFAS80	4
10	M10 PLAIN NUT ZP	ZFAS05	2
11	M10x70 SETSCREW ZP	ZFAS02	2
12	M18 WASHER ZP	ZFAS111	4

MS150 SPREADER ROTOR ASSEMBLY

BOM ID	Description	PartNo	Qty
1	CHAIN c/w WEIGHT	P001.686	14
2	ROLL PIN	MSWP	14
3	CHAIN WEIGHT	MSW3020	14
4	MS150 ROTOR	P001.685	1
5	M12x50 BOLT ZP	ZFAS15	14
6	M12 NYLOCK NUT ZP	ZFAS22	14
7	CHAIN HOLDER	ZPPA950	28

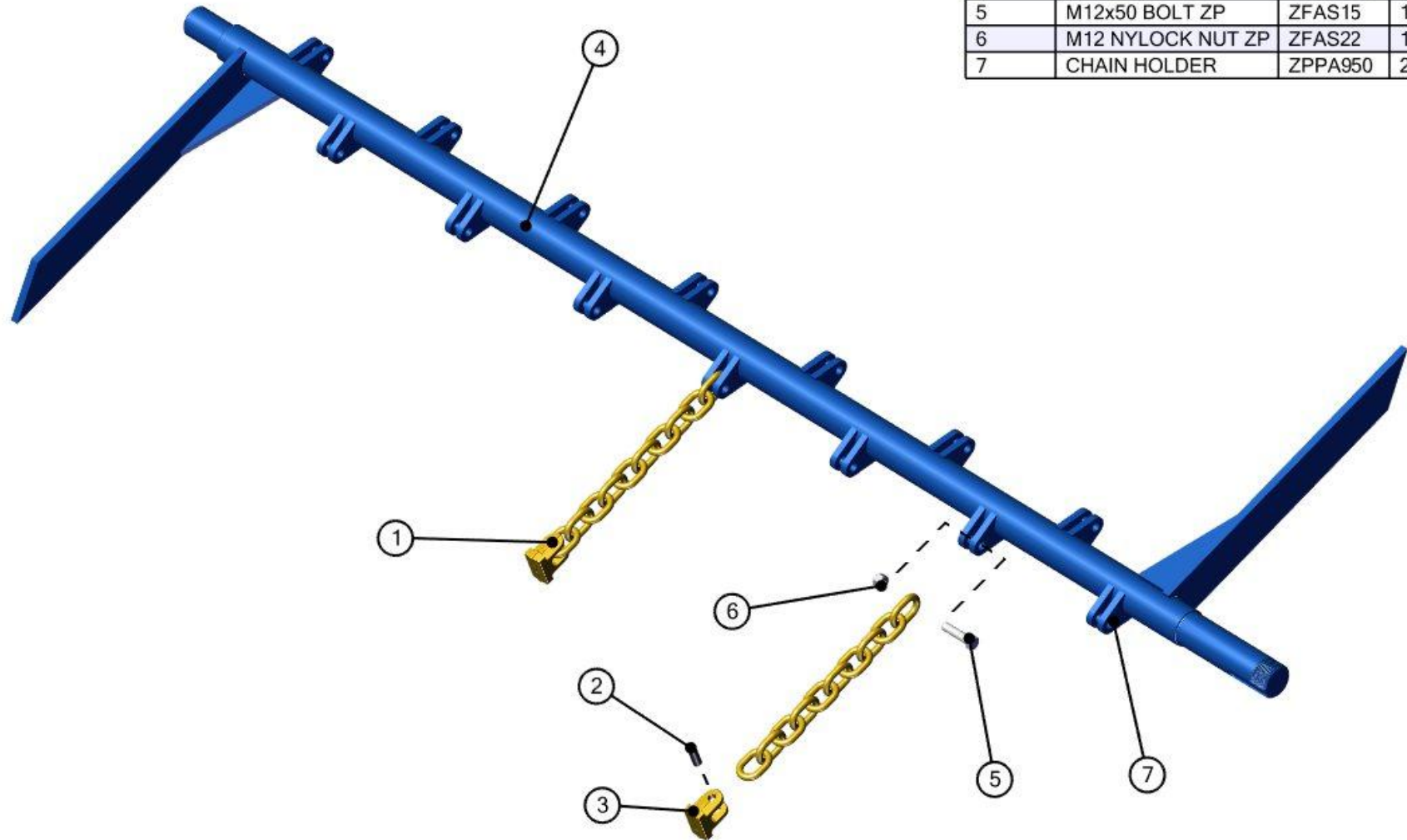

MS150 SPREADER REAR VIEW

BOM ID	Description	PartNo	Qty
1	BEARING	ZGPP48	1
2	MS150 BEARING PLATE	P001.687	1
3	M16 NYLOCK NUT ZP	ZFAS23	4
4	M16x45 SETSCREW ZP	ZFAS11	4
5	M12 NYLOCK NUT ZP	ZFAS22	6
6	M12 WASHER ZP	ZFAS45	6
7	M12x30 SETSCREW	ZFAS10	6
8	1" BSP PLUG	ZFAS32	1

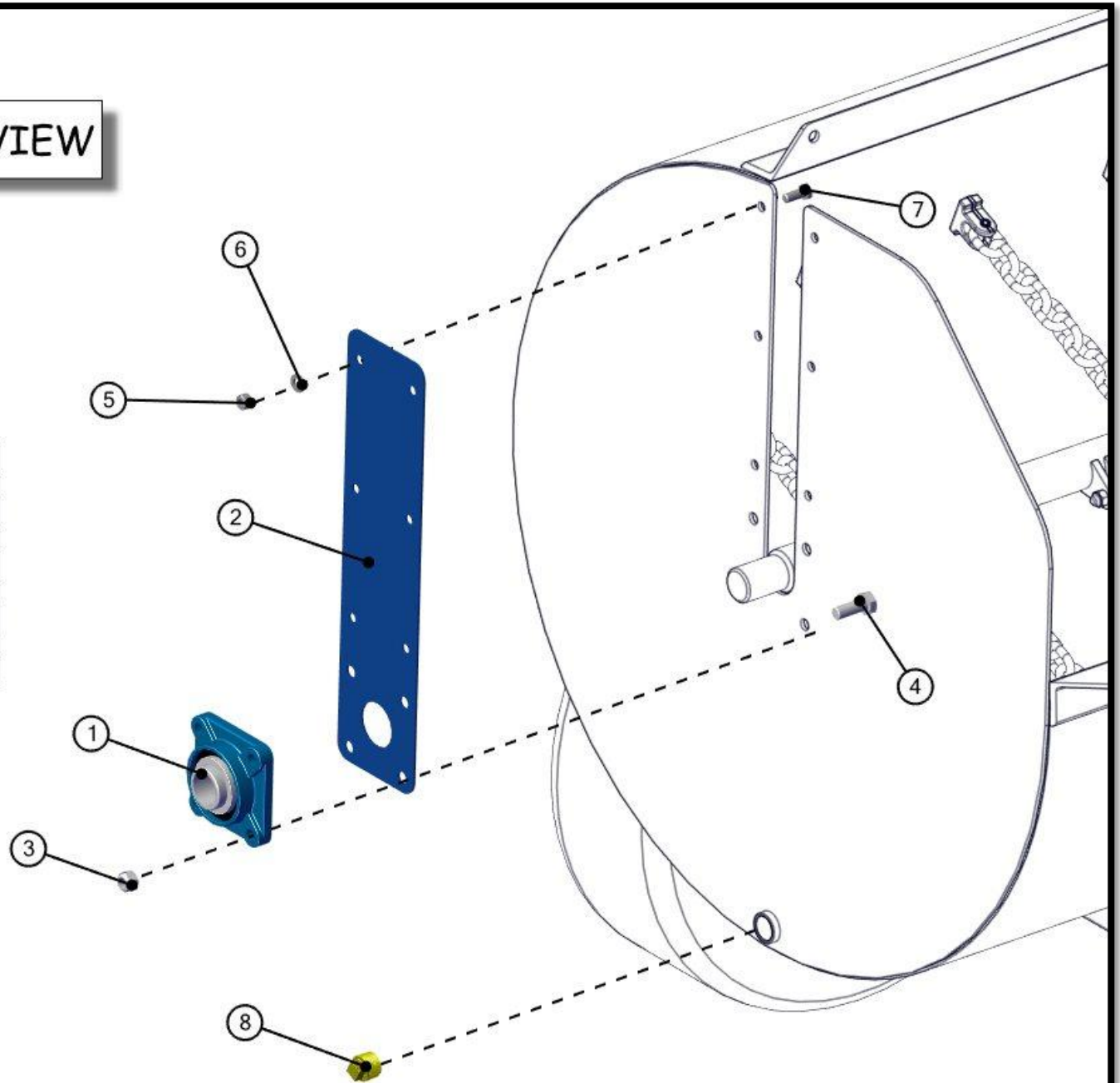

MS150 SPREADER AXLE ASSEMBLY

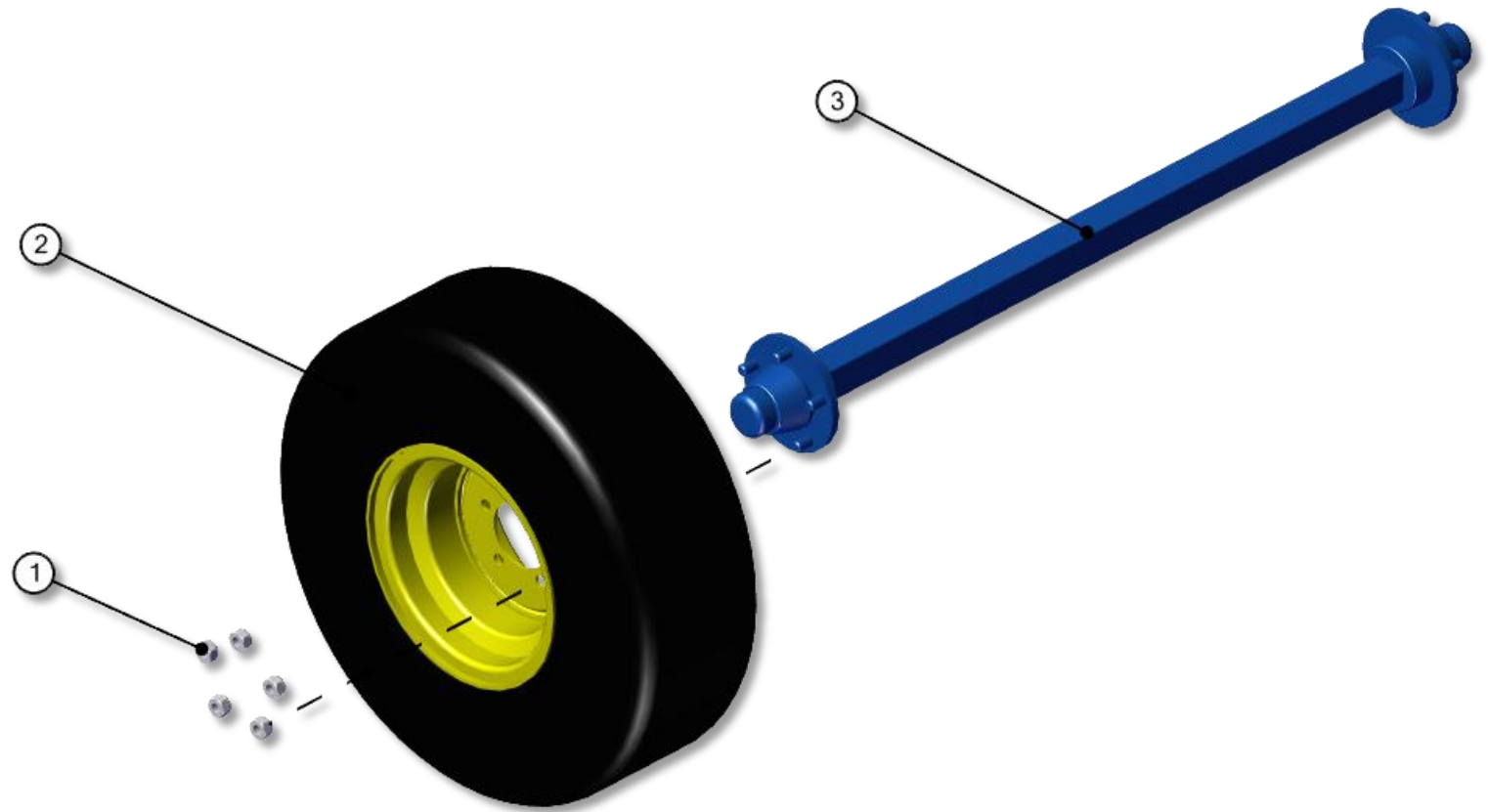

BOM ID	Description	PartNo	Qty
1	WHEEL NUT	AX-161.5	10
2	COMPLETE WHEEL	ZGPP160	2
3	COMPLETE AXLE	ZGPP159	1

MS150 SPREADER AXLE PART No. ZGPP159

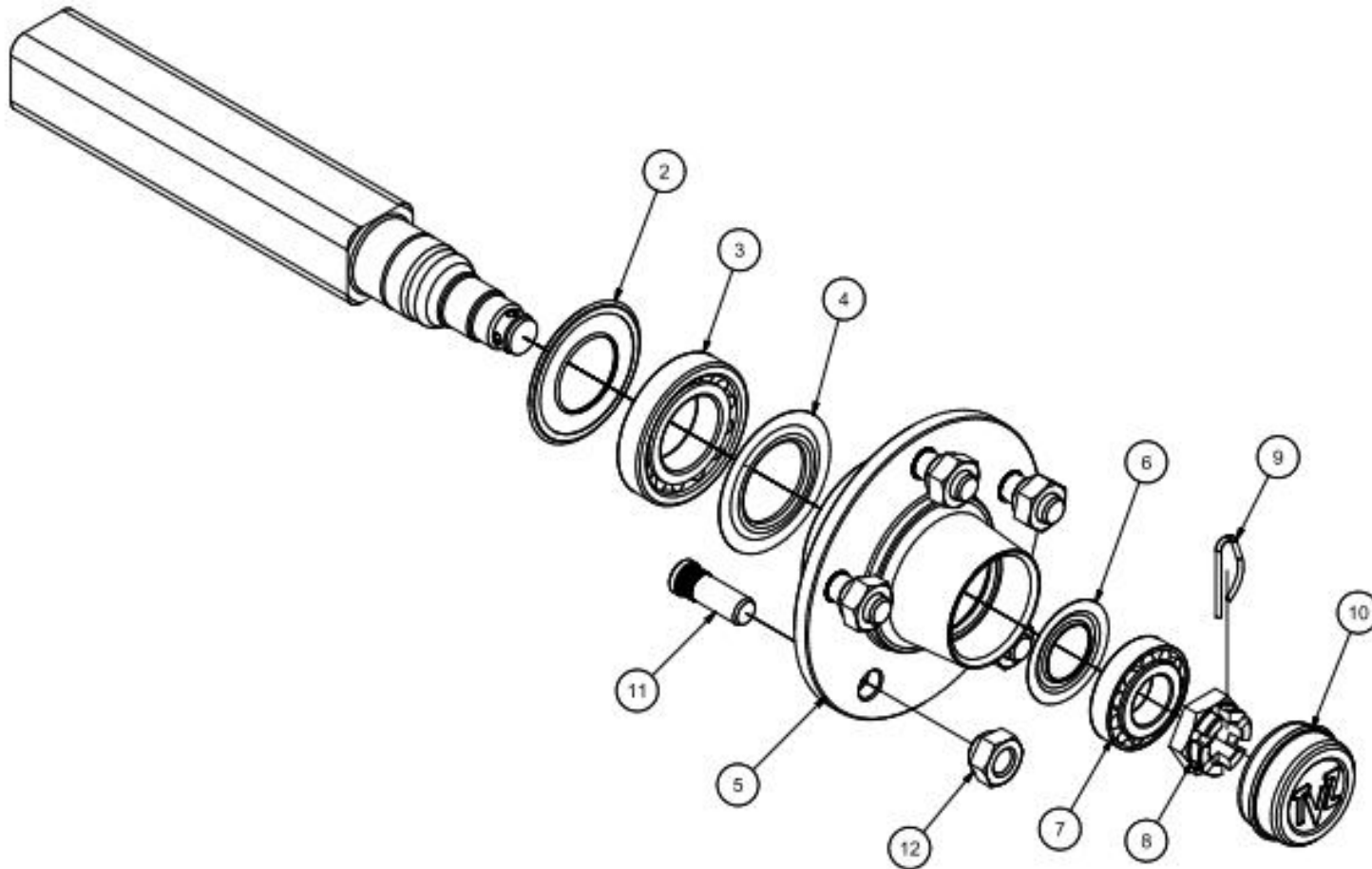

SEE TABLE NO: 001

TABLE NO: 001 MS150 AXLE PART No. ZGPP159

ITEM NO	DESCRIPTION	TR1 & TR2	
		CODE	QTY
2	DUST SHIELD	5410851	2
3	BEARING	59130209	2
4	SEAL	5510851	2
5	HUB	61L5JA006	2
6	SEAL	5510621	2
7	BEARING	59130206	2
8	CROWN NUT M27X1.50	57527B1	2
9	SPRING PIN FOR NUT	58204	2
10	DUST CAP 62mm	56106210	2
11	STUD M16X1,45	AX-16451.5	10
12	STUD NUTM16x1,50	AX-161.5	10

MS150 SPREADER PLAIN PTO SHAFT ZGPP127

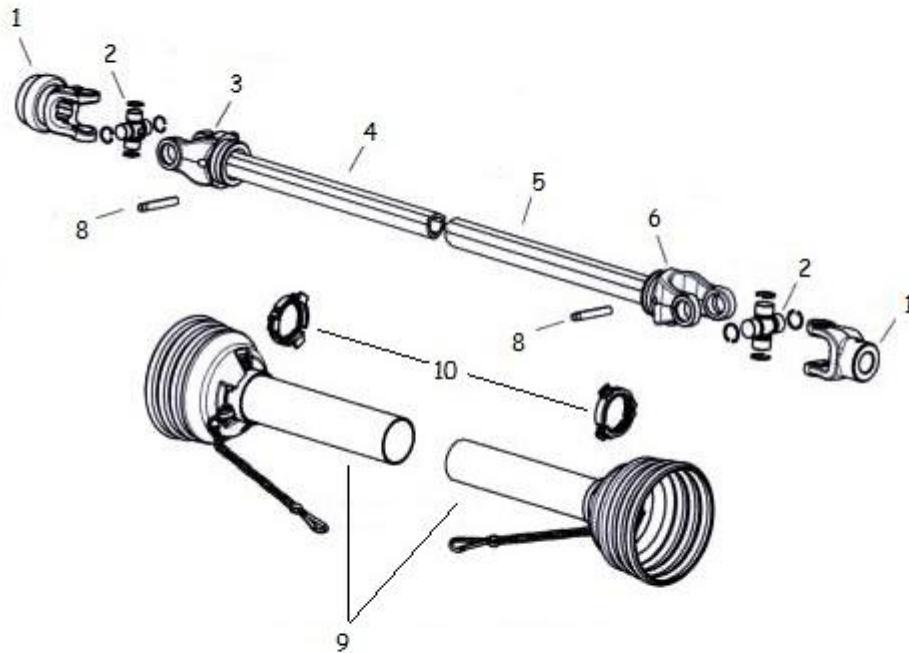

SEE TABLE NO: 002

TABLE NO: 002 MS150 SPREADER PLAIN PTO SHAFT			
ZGPP127			
POS.	PART NO.	PCS.	DESCRIPTION:
1	P6-102-8406	2	1 3/8" x 6 SPLINED YOKE
2	P6-200-8474	2	CROSS & BEARING KIT
3	P6-300-6436	1	INNER PROFILE YOKE
4	P6-610-3604-000	1	INNER PROFILE TUBE 3m
5	P6-610-4303-000	1	OUTER PROFILE TUBE 3m
6	P6-300-6443	1	OUTER PROFILE YOKE
8	P6-508-0865	1	M8 x 65mm ROLL PIN
9	P6-907-2500-116	1	SAFETY COVER
10	P6-961-2534		SAFETY COVER BEARING KIT

MS150 SPREADER PLAIN PTO SHAFT ZGPP127

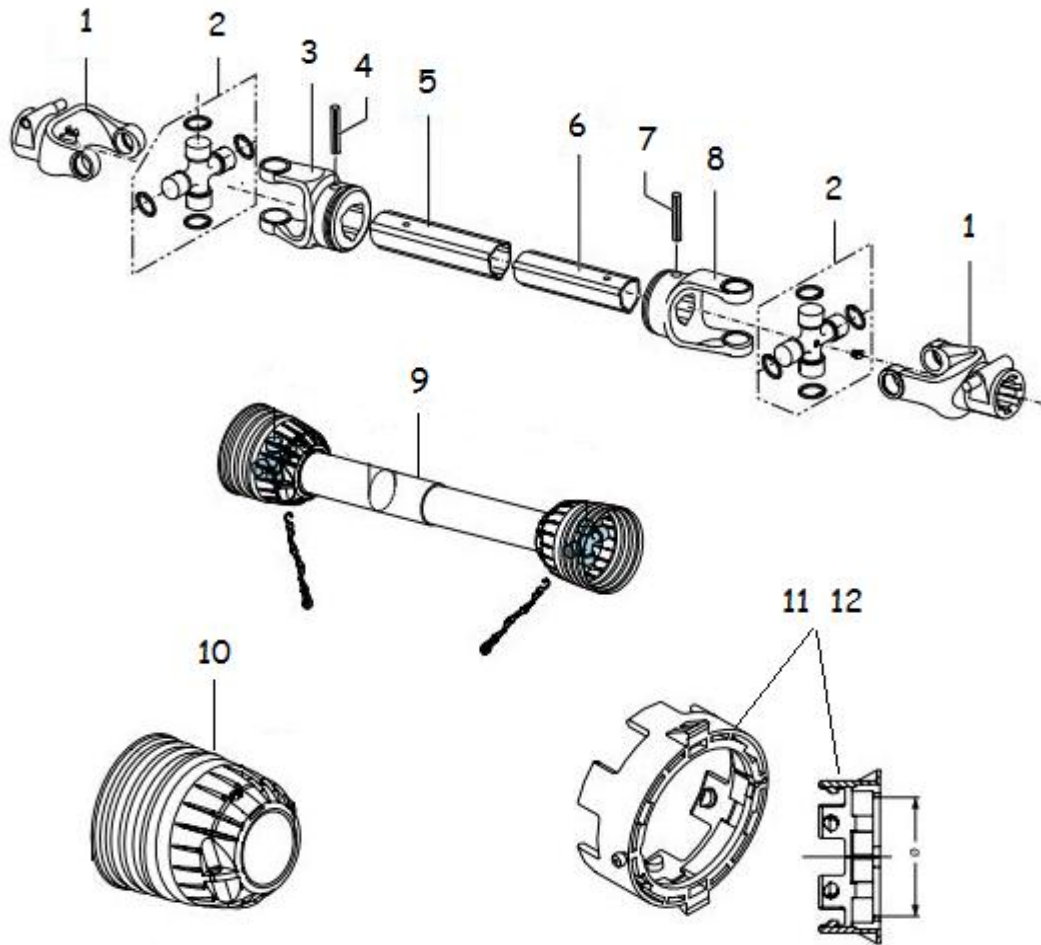

SEE TABLE NO: 003

TABLE NO: 003 MS150 SPREADER PLAIN PTO SHAFT

ZGPP127			
POS.	PART NO.	PCS.	DESCRIPTION:
1	P6C-141-024-430	2	1 3/8" x 6 SPLINED YOKE
2	P6-200-8474	2	CROSS & BEARING KIT
3	P6C-151-014-006	1	OUTER PROFILE YOKE
4	P6C-190-000-014	1	M8 x 65mm ROLL PIN
5	P6C-152-140-213-0700	1	OUTER PROFILE TUBE 965mm
6	P6C-153-140-113	1	INNER PROFILE TUBE 980mm
7	P6C-190-000-012	1	M8 x 55mm ROLL PIN
8	P6C-151-014-007	1	INNER PROFILE YOKE
9	P6C-140-340-014-9450	1	SAFETY COVER
10	P6C-180-043-510	1	SAFETY COVER CONE
11	P6C-180014505	1	(a=54mm) COVER BEARING
12	P6C-180014506	1	(a=47mm) COVER BEARING

MS20-MS1000 SIDE SPREADER SPARE PARTS LISTS



Table of Contents:

SIDE SPREADER SPARE PARTS LIST

Table 001 : MS20,MS30 and MS450 MAIN ASSEMBLY

Table 002: MS20,MS30 and MS450 FRONT VIEW

Table 003: MS20,MS30 and MS450 REAR VIEW

Table 004: MS20,MS30 and MS450 ROTOR ASSEMBLY

Table 005: MS20 GEARBOX ASSEMBLY

Table 006: MS30 and MS450 GEARBOX ASSEMBLY

Table 007: MS20,MS30 and MS450 TVZ AXLES

Table 008: MS20,MS30 and MS450 COMER PTO SHAFT ZGPP127

Table 009: MS20,MS30 and MS450 WEALSER PTO SHAFT ZGPP127

Table 010: MS700/MS1000 SIDE SPREADER ASSEMBLY

Table 011: MS700/MS1000 FRONT VIEW

Table 012: MS700/MS1000 REAR VIEW

Table 013: MS700/MS1000 LIGHTS DIAGRAM

Table 014: MS700/MS1000 SIDE SPREADER ROTOR ASSEMBLY

Table 015: MS700/MS1000 SIDE SPREADER GEARBOX ASSEMBLY

Table 016: MS700/MS1000 SIDE SPREADER BRAKE ASSEMBLY

Table 017: MS700/MS1000 SIDE SPREADER HYDRAULIC RAM ASSEMBLY

Table 018: MS1000 HYDRAULIC RAM ASSEMBLY 2012- onwards

Table 019: MS700 TVZ AXLE Part No. ZGPP120

Table 020: MS1000 TVZ AXLE Part No. ZGPP17 (New Version)

Table 021: MS1000 TVZ AXLE Part No. ZGPP17 (Old Version)

Table 022: COMER PTO SHAFT PART No. ZGPP121

Table 023: WEASLER AGDRIVE (BLACK) PTO SHAFT PART No. ZGPP121

MS20/30 & MS450 MAIN ASSEMBLY

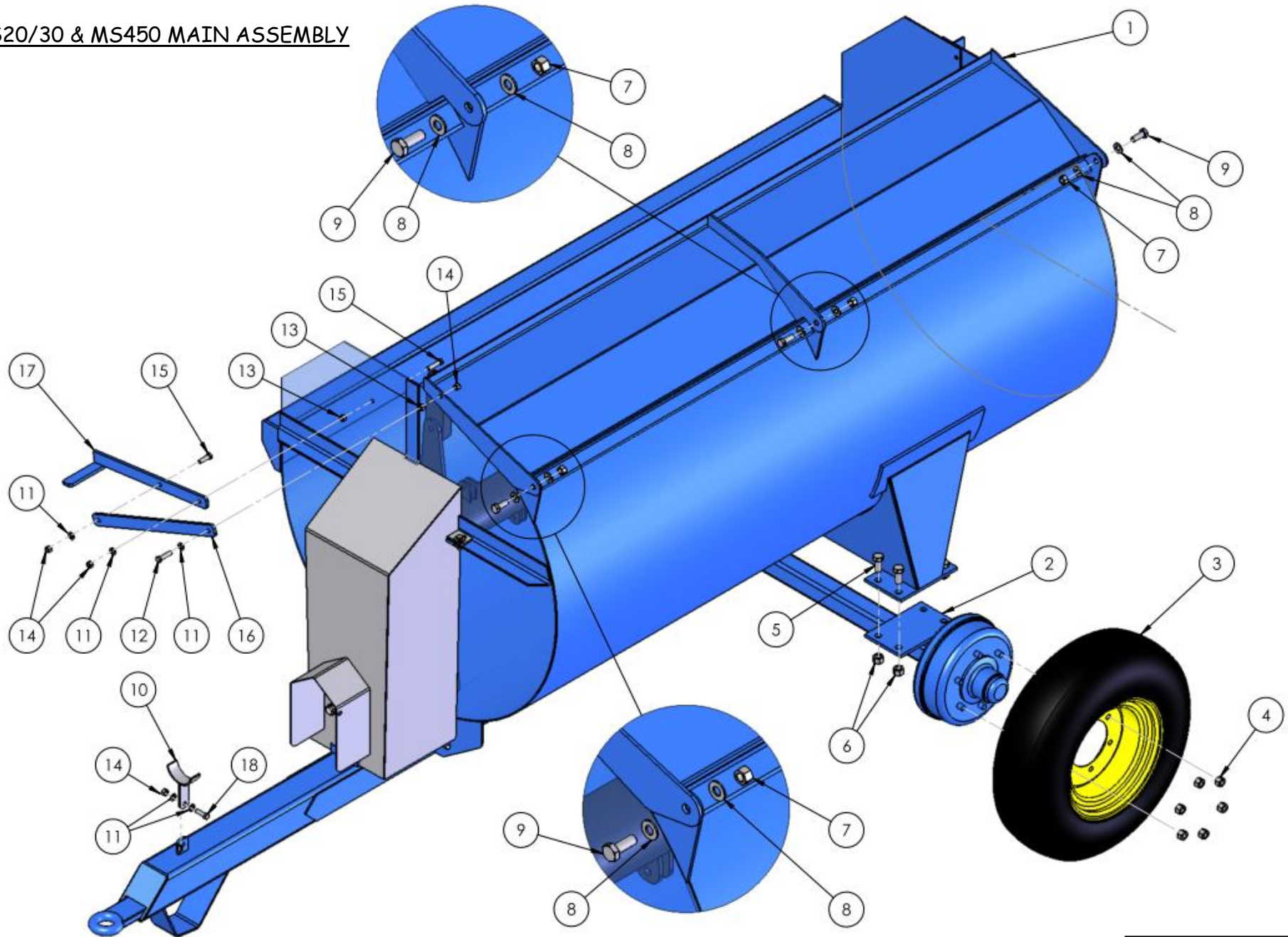

SEE TABLE NO: 001

TABLE NO: 001 MS20,MS30 and MS450 MAIN ASSEMBLY

ITEM NO	DESCRIPTION	MS20		MS30		MS450	
		CODE	QTY	CODE	QTY	CODE	QTY
1	LID	P001.311	1	P001.312	1	P001.313	1
2	AXLE (UNBRAKED)	ZGPP134	1	ZGPP130	1	ZGPP130	1
3	WHEEL	ZGPP135	2	ZGPP19	2	ZGPP19	2
4	WHEEL NUT	AX-161.6	12	AX-181.5	12	AX-181.5	12
5	M20 x 45 BOLT	ZFAS12	8	ZFAS12	8	ZFAS12	8
6	M20 NYLOCK NUT	ZFAS24	8	ZFAS24	8	ZFAS24	8
7	M16 NYLOCK NUT	ZFAS23	3	ZFAS23	3	ZFAS23	3
8	M16 WASHER ZP	ZFAS36	6	ZFAS36	6	ZFAS36	6
9	M16x45 SET SCREW ZP	ZFAS11	3	ZFAS11	3	ZFAS11	3
10	PTO SHAFT HOLDER	P001.314	1	P001.314	1	P001.314	1
11	M12 WASHER ZP	ZFAS45	5	ZFAS45	5	ZFAS45	5
12	M12x70 SET SCREW	N/A		N/A		ZFAS44	1
13	M12 PLAIN NUT ZP	N/A		N/A		ZFAS52	2
14	M12 NYLOCK NUT	ZFAS22	1	ZFAS22	1	ZFAS22	4
15	M12x50 SET SCREW	N/A		N/A		ZFAS15	2
16	STAY BAR	N/A		N/A		P001.315	1
17	HANDLE	N/A		N/A		P001.316	1
18	M12x40 SET SCREW	ZFAS51	1	ZFAS51	1	ZFAS51	1
19	STICKER KIT	P001.539	1	P001.540	1	P001.541	1

MS20/30 & MS450 FRONT VIEW

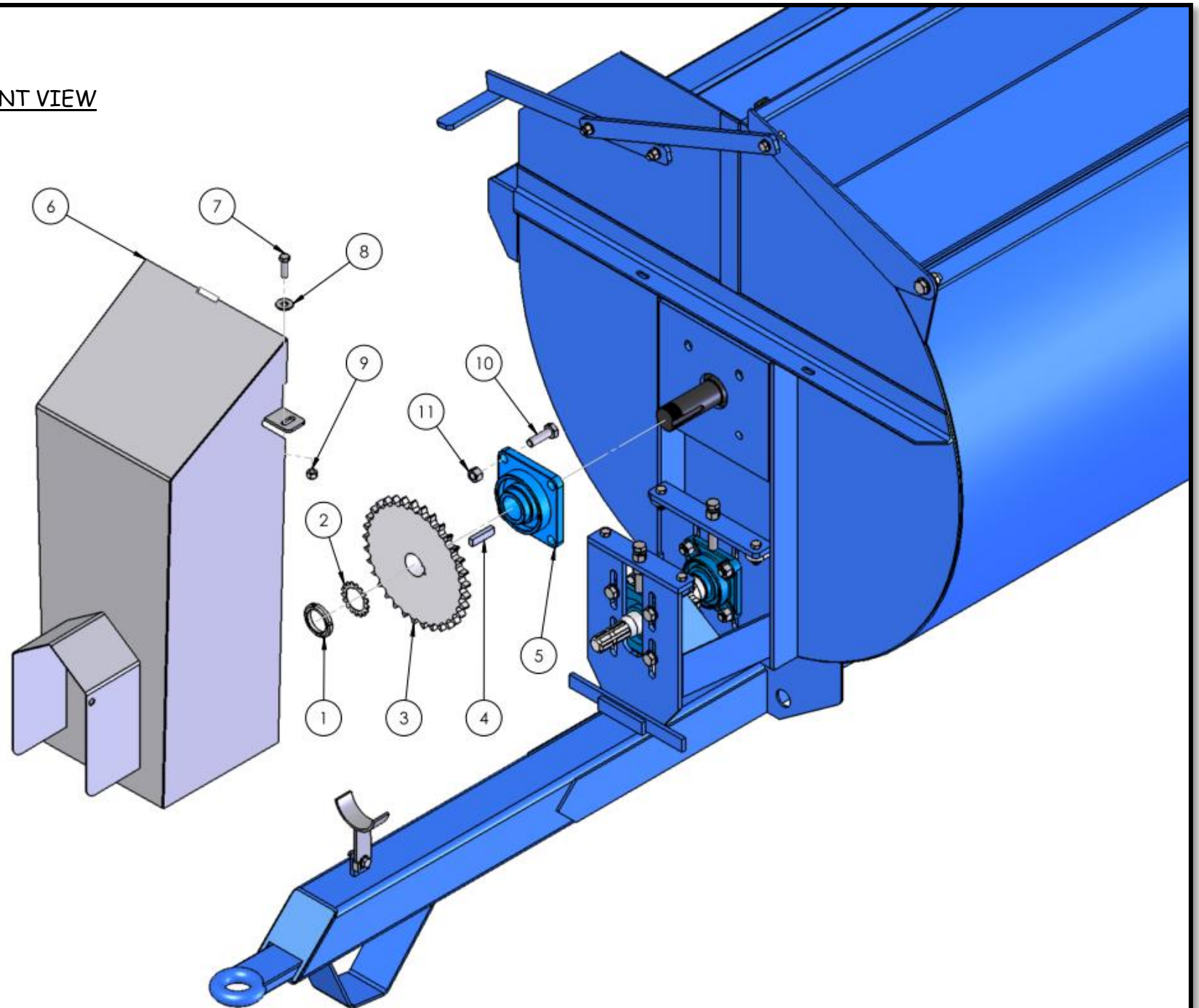

SEE TABLE NO: 002

TABLE NO: 002 MS20,MS30 and MS450 FRONT VIEW

ITEM NO	DESCRIPTION	MS20		MS30		MS450	
		CODE	QTY	CODE	QTY	CODE	QTY
1	C-NUT	ZFAS90	1	ZFAS84	1	ZFAS84	1
2	TAB WASHER	ZFAS91	1	ZFAS85	1	ZFAS85	1
3	SPROCKET	ZDRI18	1	ZDRI18	1	ZDRI11	1
4	KEYWAY	P001.317C	1	P001.317C	1	P001.317C	1
5	BEARING	ZDRI10	1	ZDRI10	1	ZDRI16	1
6	SAFETY GUARD	P001.318	1	P001.319	1	P001.320	1
7	M12x40 SET SCREW ZP	ZFAS51	2	ZFAS51	2	ZFAS51	2
8	M12 WASHER ZP	ZFAS45	2	ZFAS45	2	ZFAS45	2
9	M12 NYLOCK NUT	ZFAS22	2	ZFAS22	2	ZFAS22	2
10	M16x55 BOLT ZP	ZFAS62	4	ZFAS62	4	ZFAS62	4
11	M16 NYLOCK NUT	ZFAS23	4	ZFAS23	4	ZFAS23	4

MS20/30 & MS450 REAR VIEW

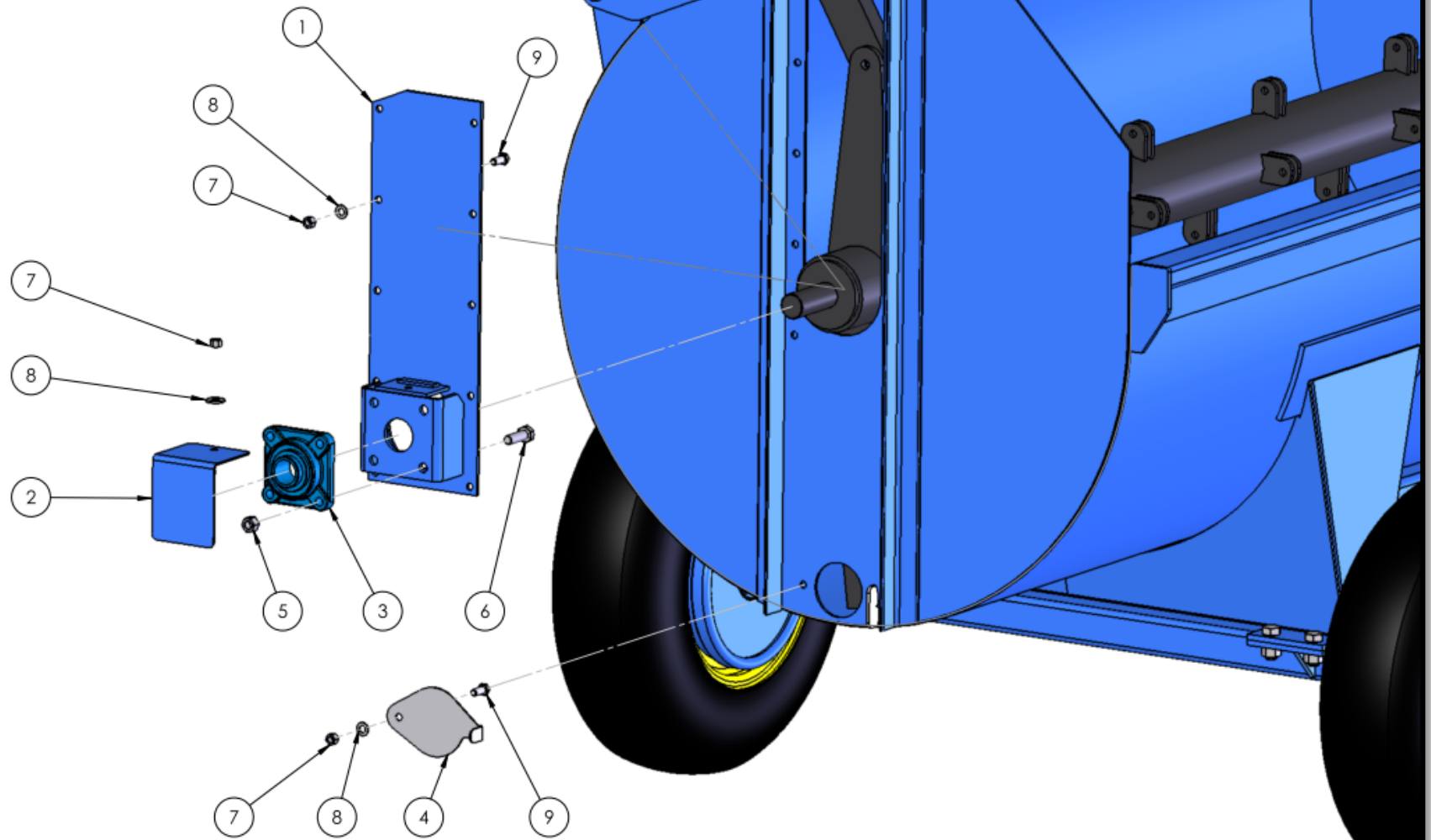

SEE TABLE NO: 003

TABLE NO: 003 MS20,MS30 and MS450 REAR VIEW

ITEM NO	DESCRIPTION	MS20		MS30		MS450	
		CODE	QTY	CODE	QTY	CODE	QTY
1	BEARING SUPPORT PLATE	P001.321	1	P001.322	1	P001.323	1
2	BEARING COVER	P001.324	1	P001.324	1	P001.324	1
3	BEARING	ZGPP48	1	ZGPP48	1	ZGPP48	1
4	DRAIN COVER	P001.325	1	P001.325	1	P001.325	1
5	M16 NYLOCK NUT	ZFAS23	4	ZFAS23	4	ZFAS23	4
6	M16x45 SET SCREW ZP	ZFAS11	4	ZFAS11	4	ZFAS11	4
7	M12 NYLOCK NUT	ZFAS22	12	ZFAS22	12	ZFAS22	12
8	M12 WASHER ZP	ZFAS45	12	ZFAS45	12	ZFAS45	12
9	M12x30 SET SCREW ZP	ZFAS10	12	ZFAS10	12	ZFAS10	12

MS20/30 & MS450 ROTOR ASSEMBLY

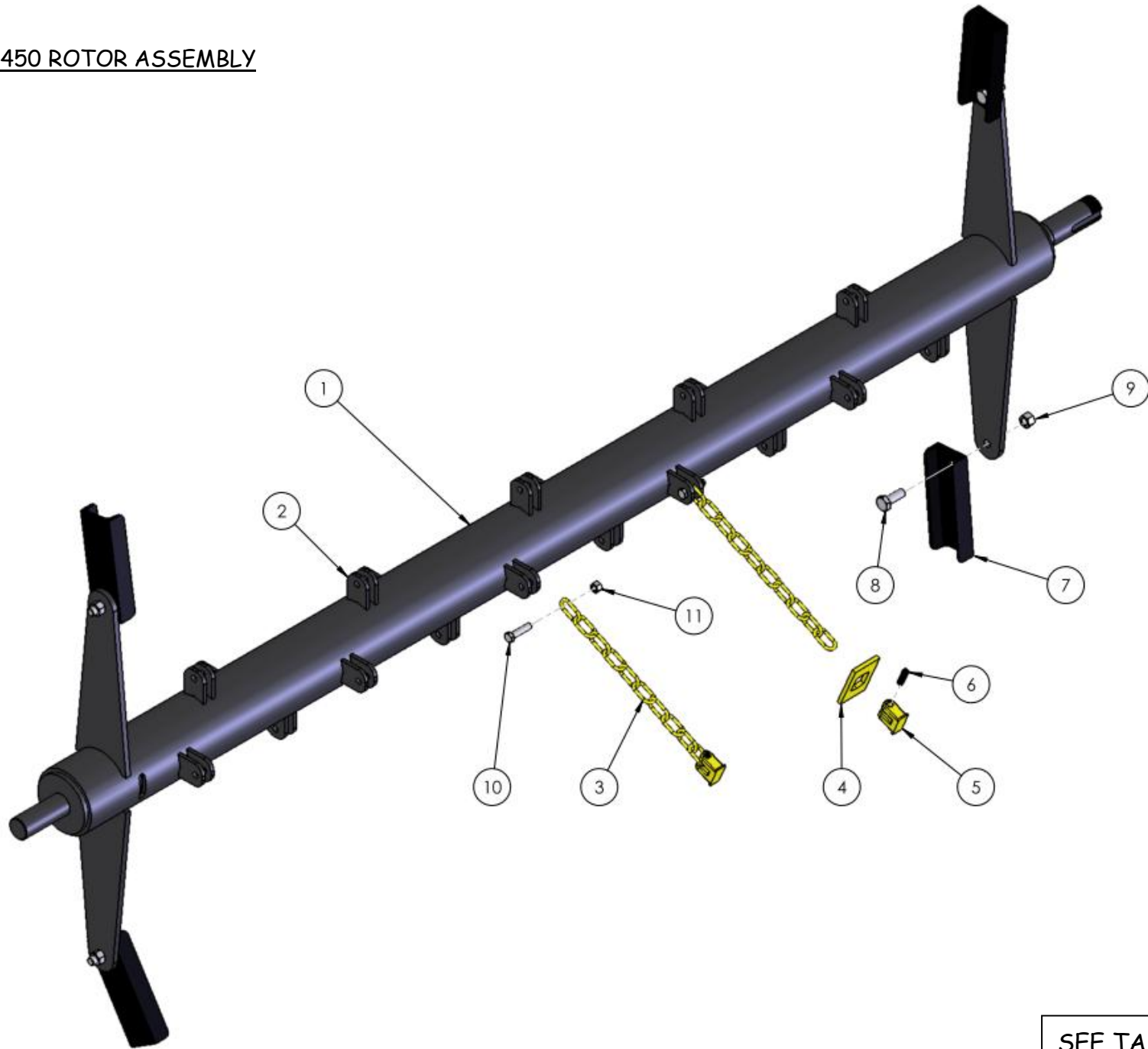

SEE TABLE NO: 004

TABLE NO: 004 MS20,MS30 and MS450 ROTOR ASSEMBLY

ITEM NO	DESCRIPTION	MS20		MS30		MS450	
		CODE	QTY	CODE	QTY	CODE	QTY
1	ROTOR	P001.326	1	P001.327	1	P001.328	1
2	CHAIN MOUNTING BRACKET	ZPPA361	40	ZPPA248	40	ZPPA248A	40
3	MUCKSPREADER CHAIN PLUS WEIGHT	ZGPP125	20	ZGPP123	20	ZGPP169A	20
4	MUCKSPREADER PLATE	ZGPP123	20	ZGPP123	20	ZGPP123	20
5	MUCKSPREADER WEIGHT	MSW3020	20	MSW3020	20	MSW3020	20
6	MUCKSPREADER ROLL PIN	MSWP	20	MSWP	20	MSWP	20
7	STARTER BAR	P001.329	4	P001.329	4	P001.329	4
8	M16x45 SET SCREW ZP	ZFAS11	4	ZFAS11	4	ZFAS11	4
9	M16 NYLOCK NUT	ZFAS23	4	ZFAS23	4	ZFAS23	4
10	M12x50 BOLT ZP	ZFAS15	20	ZFAS15	20	ZFAS15	20
11	M12 NYLOCK NUT	ZFAS22	20	ZFAS22	20	ZFAS22	20

MS20 GEARBOX ASSEMBLY

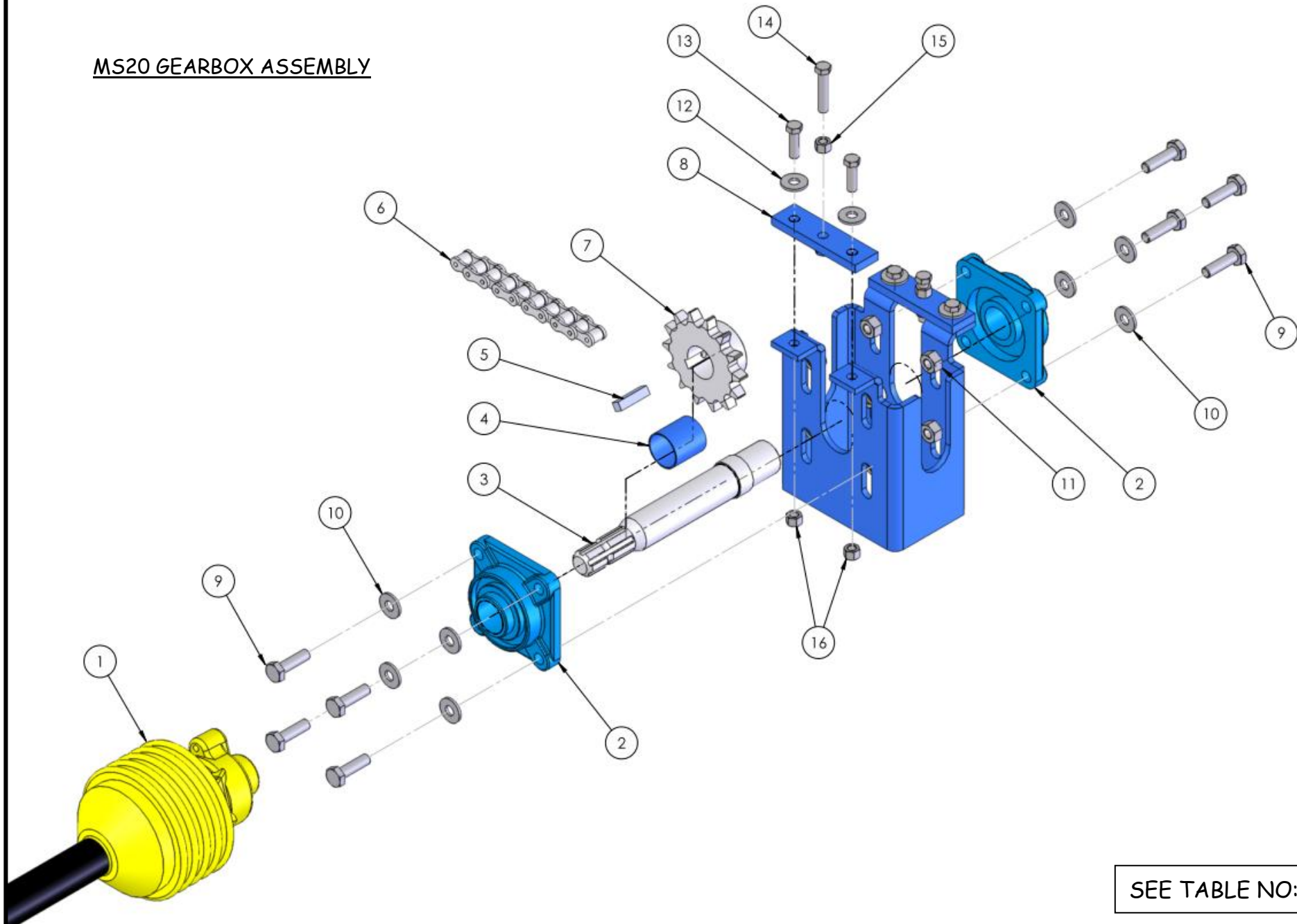

SEE TABLE NO: 005

TABLE NO: 005 MS20 GEARBOX ASSEMBLY			
ITEM NO	DESCRIPTION	MS20	
		CODE	QTY
1	PTO SHAFT	ZGPP127	1
2	BEARING	ZGPP48	2
3	INPUT SHAFT	ZMAC21	1
4	SPACER	P001.330	1
5	KEYWAY	P001.331	1
6	DRIVE CHAIN	ZDRI19	1
7	INPUT SHAFT COG	ZDRI13	1
8	TENSIONER PLATE	P001.332	2
9	M14X50 BOLT ZP	ZFAS41	8
10	M14 WASHER ZP	ZFAS88	8
11	M14 NYLOCK NUT	ZFAS42	8
12	12mm WASHER ZP	ZFAS45	4
13	M12X40 SET SCREW ZP	ZFAS51	4
14	M12X100 SET SCREW ZP	ZFAS43	2
15	M12 PLAIN NUT ZP	ZFAS52	2
16	M12 NYLOCK	ZFAS22	11

MS30/MS450 GEARBOX ASSEMBLY

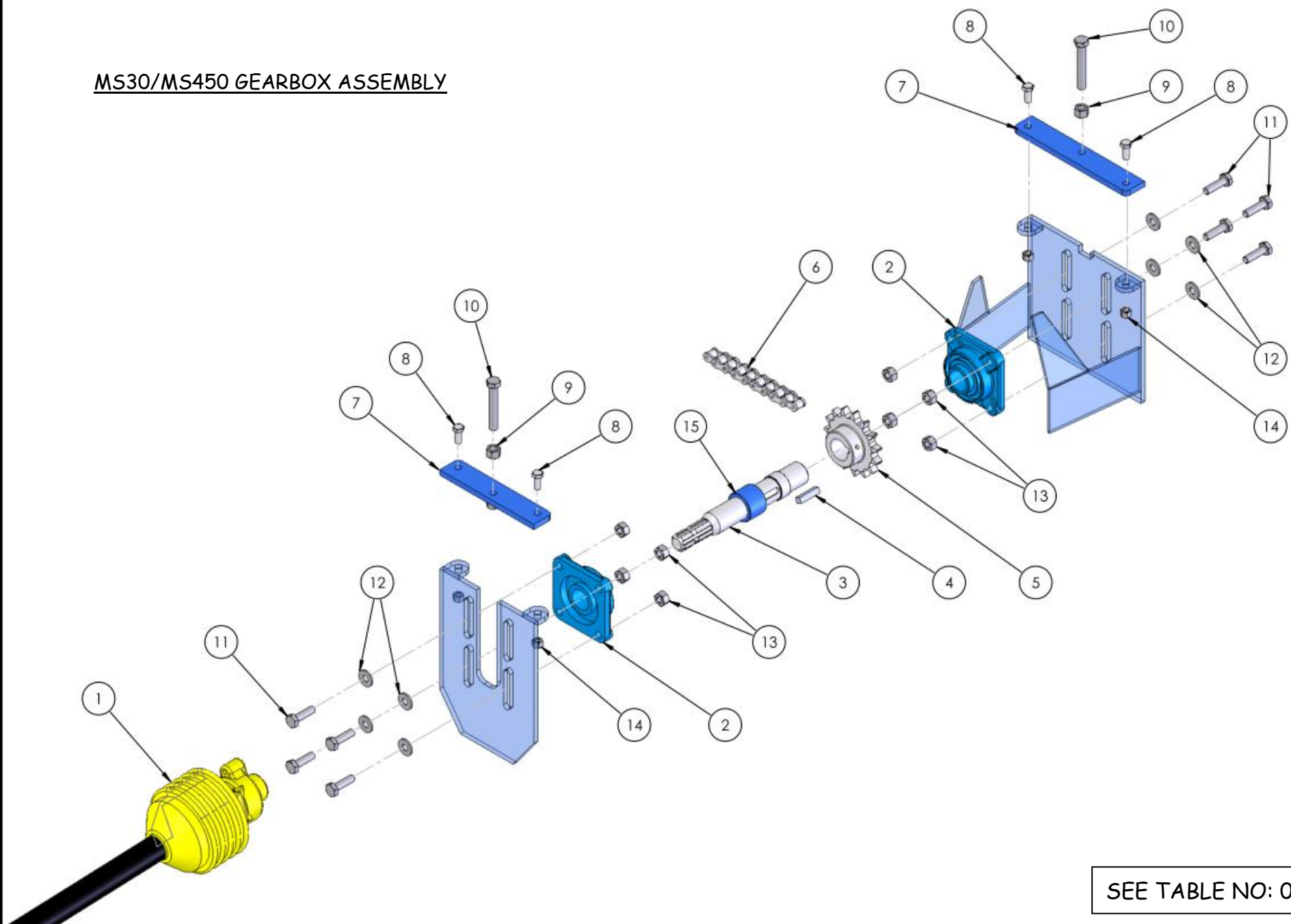

SEE TABLE NO: 006

TABLE NO: 006 M30/MS450 GEARBOX ASSEMBLY					
ITEM NO	DESCRIPTION	MS20		MS450	
		CODE	QTY	CODE	QTY
1	PTO SHAFT	ZGPP127	1	ZGPP127	1
2	BEARING	ZGPP48	2	ZGPP48	2
3	INPUT SHAFT	ZMAC21	1	ZMAC21	1
4	KEYWAY	P001.333A	1	P001.333A	1
5	INPUT SHAFT COG	ZDRI13	1	ZDRI13	1
6	DRIVE CHAIN	ZDRI22	1	ZDRI22	1
7	TENSIONER PLATE	P001.334	2	P001.334	2
8	M12X40 SET SCREW ZP	ZFAS51	4	ZFAS51	4
9	M12 PLAIN NUT ZP	ZFAS52	2	ZFAS52	2
10	M12X100 SET SCREW ZP	ZFAS43	2	ZFAS43	2
11	M14X50 BOLT ZP	ZFAS41	8	ZFAS41	8
12	M14 WASHER ZP	ZFAS88	8	ZFAS88	8
13	M14 NYLOCK NUT	ZFAS42	8	ZFAS42	8
14	M12 NYLOCK	ZFAS22	4	ZFAS22	4
15	SPACER	P001.335	1	P001.335	1

MS20,MS30 and MS450 TVZ AXLES PARTS No.s ZGPP130 & ZGPP134

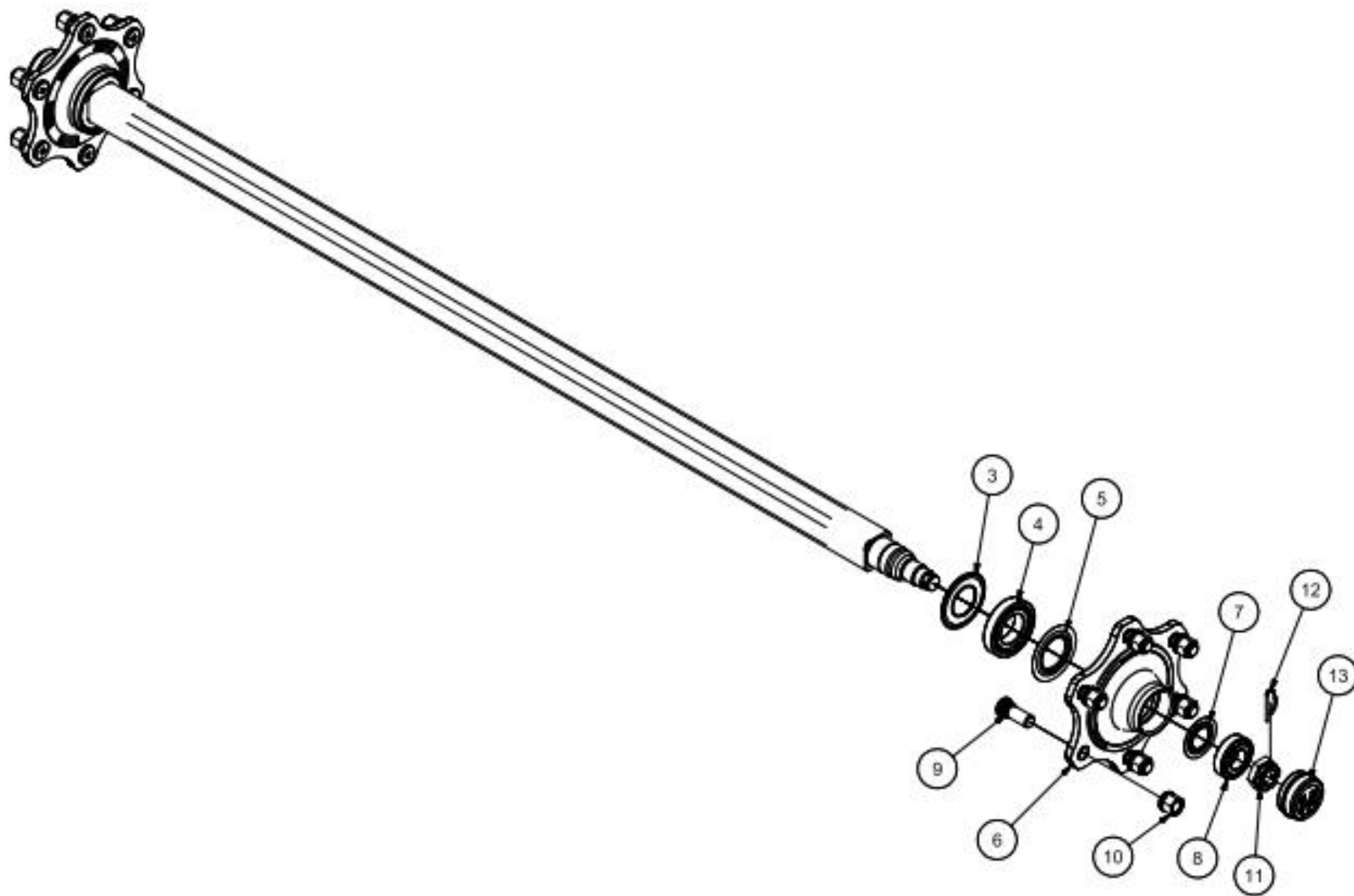

SEE TABLE NO: 007

TABLE NO: 007 MS20,MS30 and MS450 TVZ AXLES			
ZGPP134 and ZGPP130			
ITEM	PART NO.	QTY.	DESCRIPTION:
1	ZGPP134	1	MS20 AXLE COMPLETE
1	ZGPP130	1	MS30/MS450 AXLE COMPLETE
3	5410851	2	REAR SEAL
4	59130209	2	REAR BEARING
5	5510851	2	INNER SEAL
6	61L6JA002	2	HUB
7	5510621	2	OUTER SEAL
8	59130206	2	OUTER BEARING
9	AX-18501.5	12	AXLE STUD 18mmx1.5mmx50mm
10	AX-181.5	12	AXLE NUT 18mmx1.5mm
11	57527B1	2	CASTLE NUT
12	58204	2	SPRING PIN
13	56106210	2	DUST CAP

MS20,MS30 and MS450 COMER PTO SHAFT ZGPP127

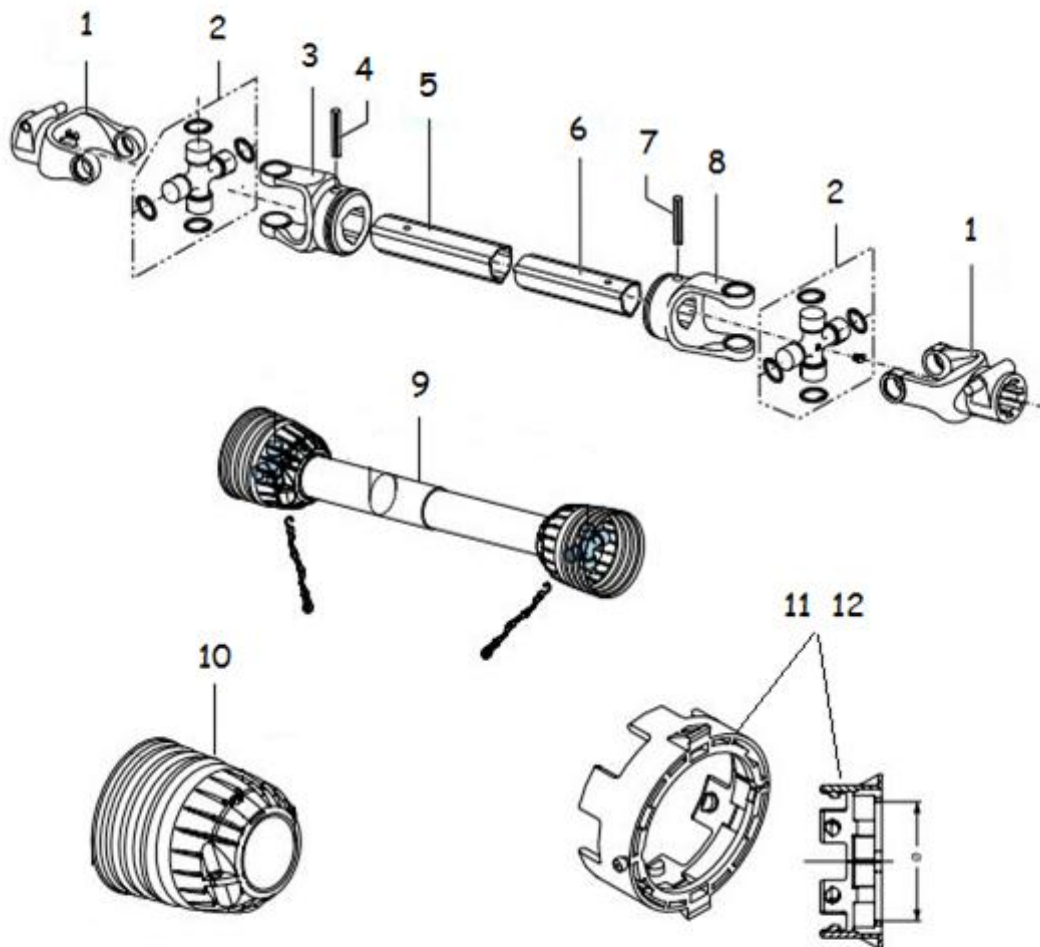

SEE TABLE NO: 008

TABLE NO: 008 MS20,MS30 and MS450 PTO SHAFT

ZGPP127

POS.	PART NO.	PCS.	DESCRIPTION:
1	P6C-141-024-430	2	1 3/8" x 6 SPLINED YOKE
2	P6-200-8474	2	CROSS & BEARING KIT
3	P6C-151-014-006	1	OUTER PROFILE YOKE
4	P6C-190-000-014	1	M8 x 65mm ROLL PIN
5	P6C-152-140-213-0700	1	OUTER PROFILE TUBE 965mm
6	P6C-153-140-113	1	INNER PROFILE TUBE 980mm
7	P6C-190-000-012	1	M8 x 55mm ROLL PIN
8	P6C-151-014-007	1	INNER PROFILE YOKE
9	P6C-140-340-014-9450	1	SAFETY COVER
10	P6C-180-043-510	1	SAFETY COVER CONE
11	P6C-180014505	1	(a=54mm) COVER BEARING
12	P6C-180014506	1	(a=47mm) COVER BEARING

M20,MS30 and MS450 WEASLER PTO SHAFT ZGPP127

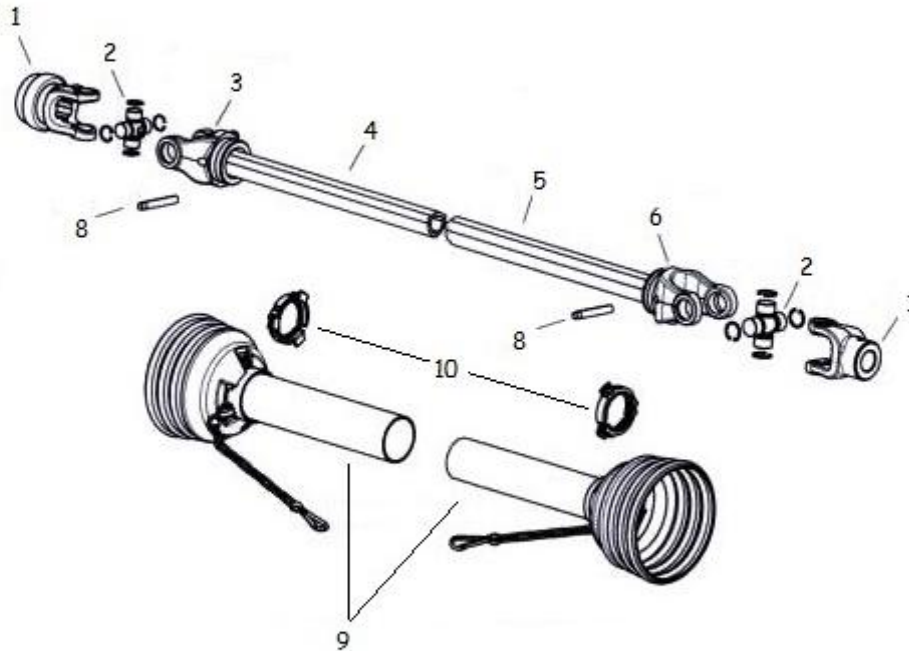

SEE TABLE NO: 009

TABLE NO: 009 MS20,MS30 & MS450 WEASLER PTO SHAFT			
ZGPP127			
POS.	PART NO.	PCS.	DESCRIPTION:
1	P6-102-8406	2	1 3/8" x 6 SPLINED YOKE
2	P6-200-8474	2	CROSS & BEARING KIT
3	P6-300-6436	1	INNER PROFILE YOKE
4	P6-610-3604-000	1	INNER PROFILE TUBE 3m
5	P6-610-4303-000	1	OUTER PROFILE TUBE 3m
6	P6-300-6443	1	OUTER PROFILE YOKE
8	P6-508-0865	1	M8 x 65mm ROLL PIN
9	P6-907-2500-116	1	SAFETY COVER
10	P6-961-2534	1	SAFETY COVER BEARING KIT

MS700/MS1000 ASSEMBLY:

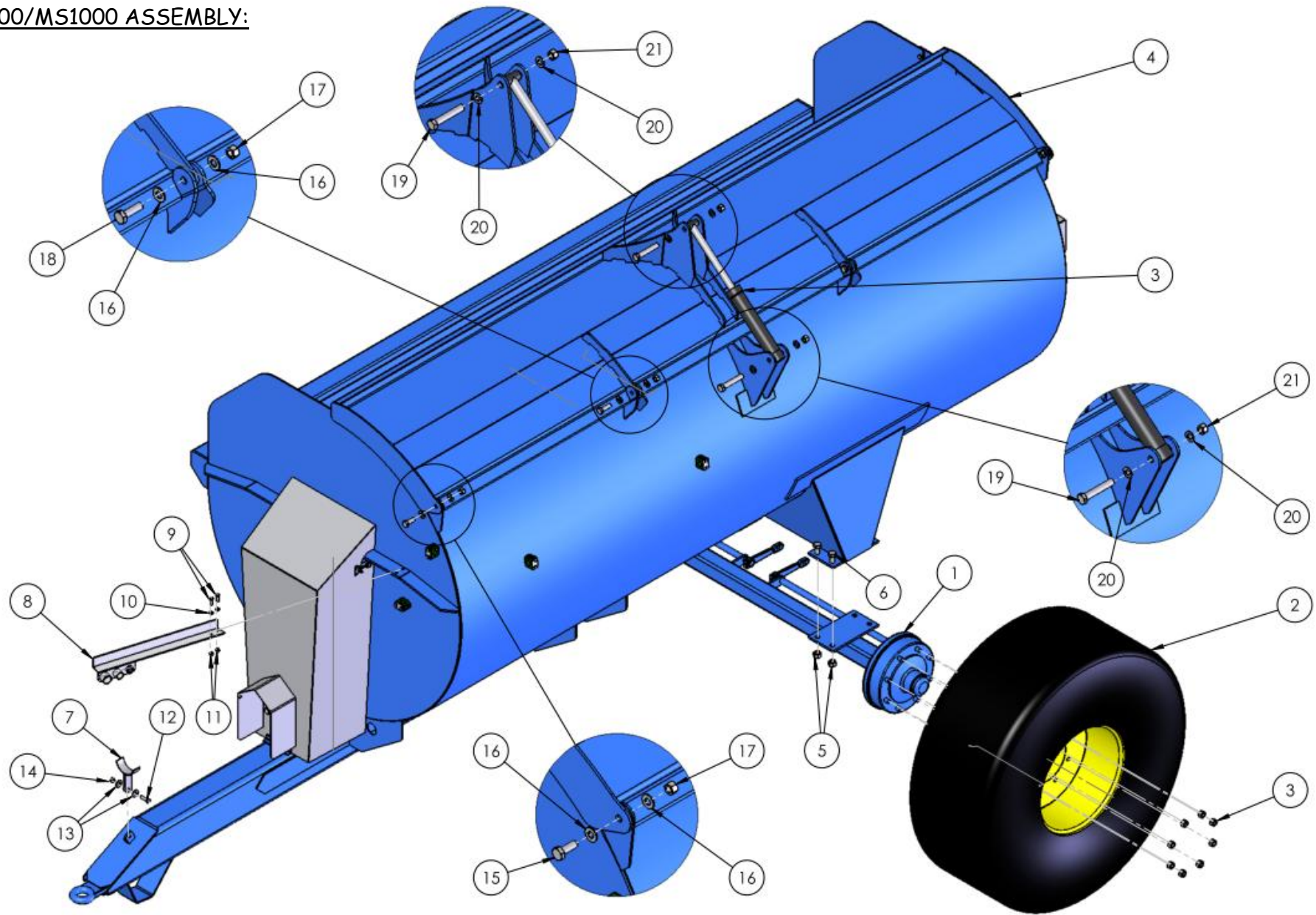

SEE TABLE NO: 010

TABLE NO: 010 M700/MS1000 SIDE SPREADER ASSEMBLY

ITEM NO	DESCRIPTION	MS700		MS1000	
		CODE	QTY	CODE	QTY
1	BRAKED AXLE	ZGPP120	1	ZGPP17	1
2	COMPLETE WHEEL	ZGPP119	2	ZGPP16	2
2	OPTIONAL WHEEL 550x45x22.5 6 STUD	ZGPP49	2	N/A	
3	AXLE NUT 18mmx1.5mm	AX-181.5	12	AX-181.5	16
4	LID	P001.336	1	PAGE 20-22	1
5	M20 NYLOCK NUT ZP	ZFAS24	8	ZFAS24	8
6	M20X45 SET SCREW ZP	ZFAS12	8	ZFAS12	8
7	PTO SHAFT HOLDER	P001.314	1	P001.314	1
8	HOSE HOLDER	P001.337	1	P001.338	1
9	M10X40 SET SCREW ZP	ZFAS105	2	ZFAS105	2
10	M10 WASHER ZP	ZFAS03	4	ZFAS03	4
11	M10 NYLOCK NUT	ZFAS20	2	ZFAS20	2
12	M12X40 SET SCREW ZP	ZFAS51	1	ZFAS51	1
13	M12 WASHER ZP	ZFAS45	2	ZFAS45	2
14	M12 NYLOCK NUT	ZFAS22	1	ZFAS22	1
15	M16X55 SET SCREW ZP	ZFAS62	2	ZFAS62	2
16	M16 WASHER ZP	ZFAS36	8	ZFAS36	8
17	M16 NYLOCK NUT	ZFAS23	4	ZFAS23	4
18	M16X60 SET SCREW ZP	ZFAS82	2	ZFAS82	2
19	M18X120 BOLT ZP	ZFAS110	2	ZFAS110	2
20	M18 WASHER ZP	ZFAS111	4	ZFAS111	4
21	M18 NYLOCK NUT	ZFAS80	2	ZFAS80	2
22	STICKER KIT	P001.542	1	P001.543	1

M570 SIDE SPREADER LID 2005-2009

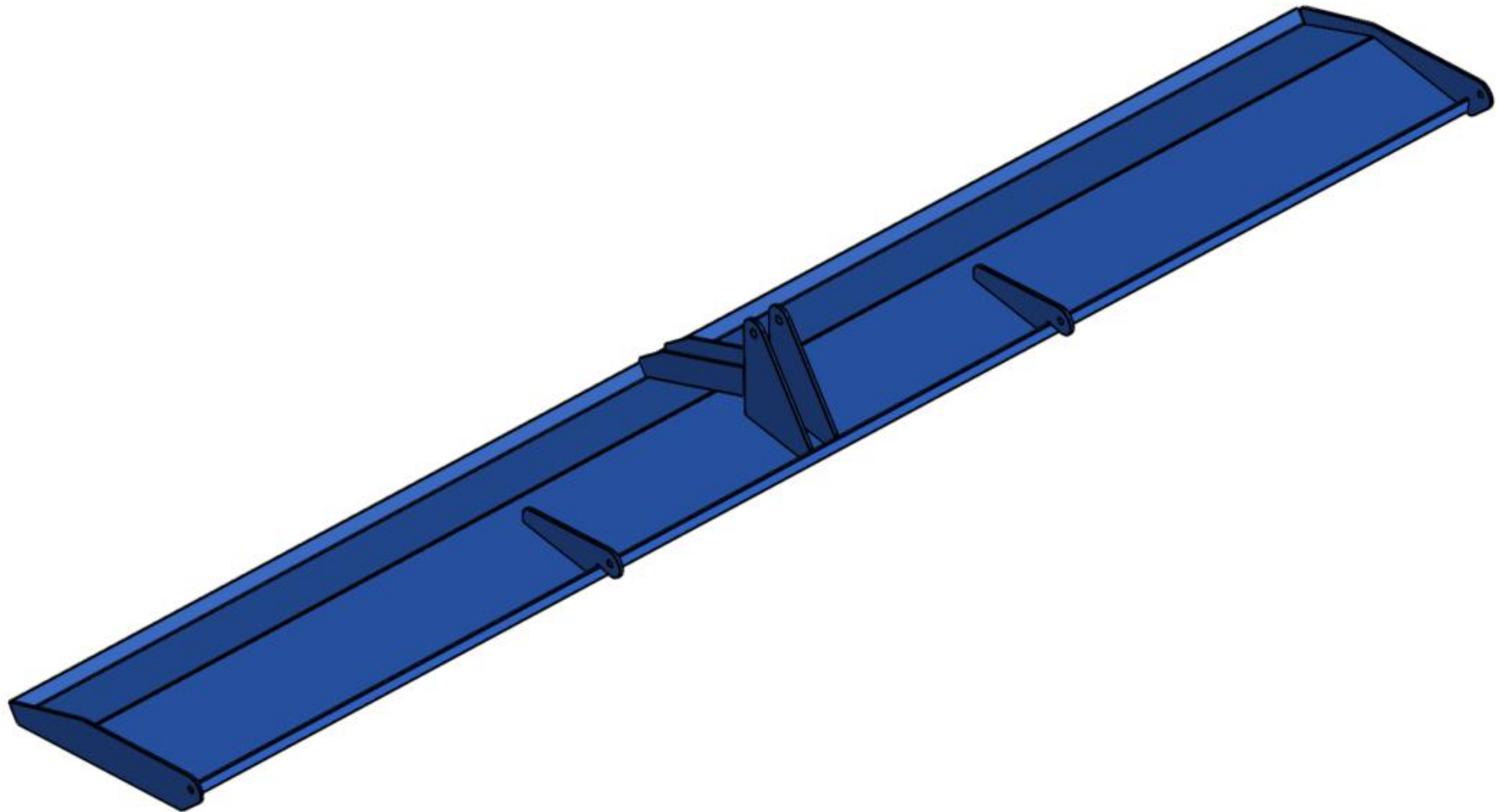

PART NO: P001.339

M570 SIDE SPREADER LID 2009-2012

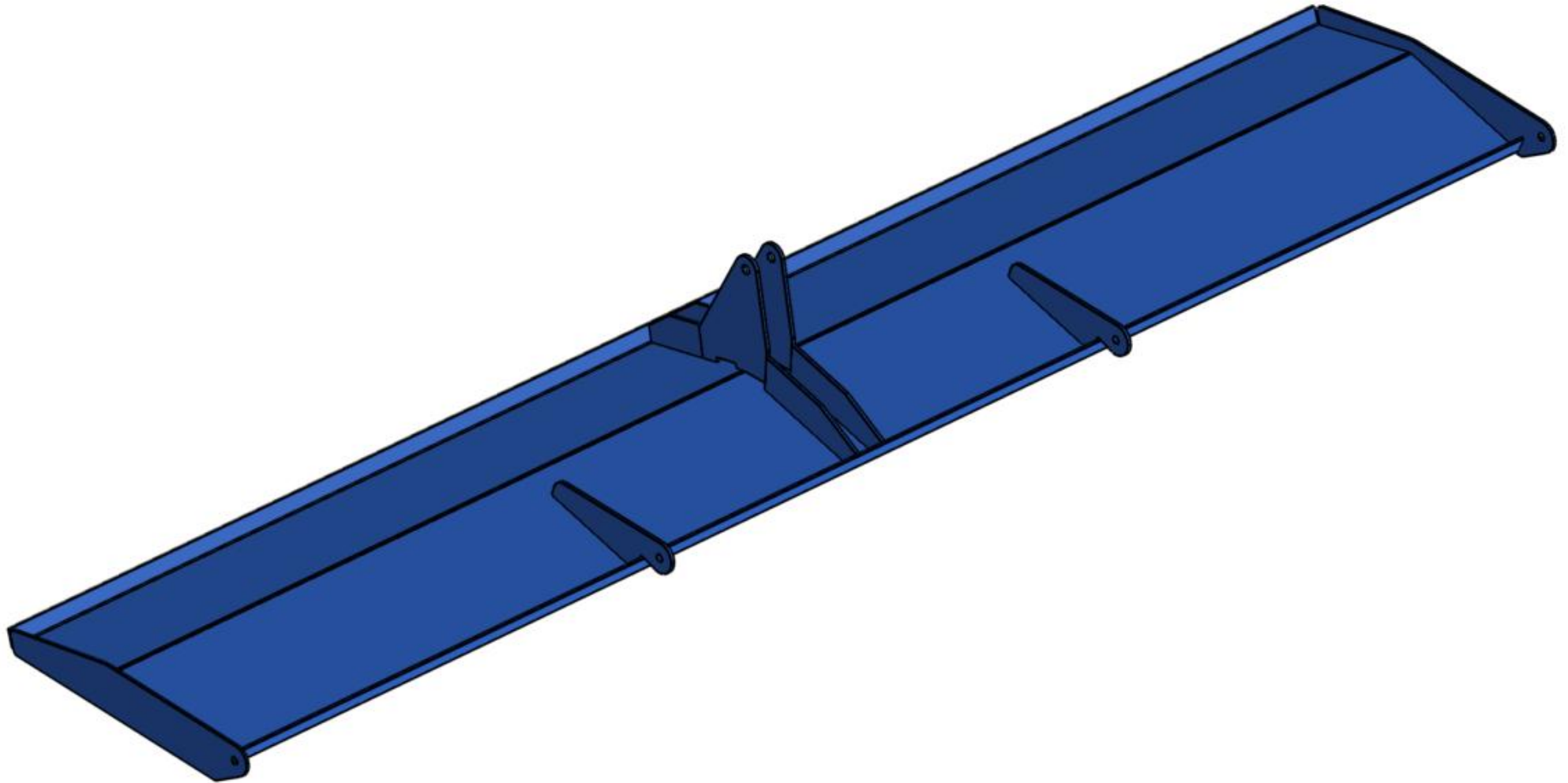

PART NO: P001.340

MS1000 SIDE SPREADER LID 2012 ONWARDS

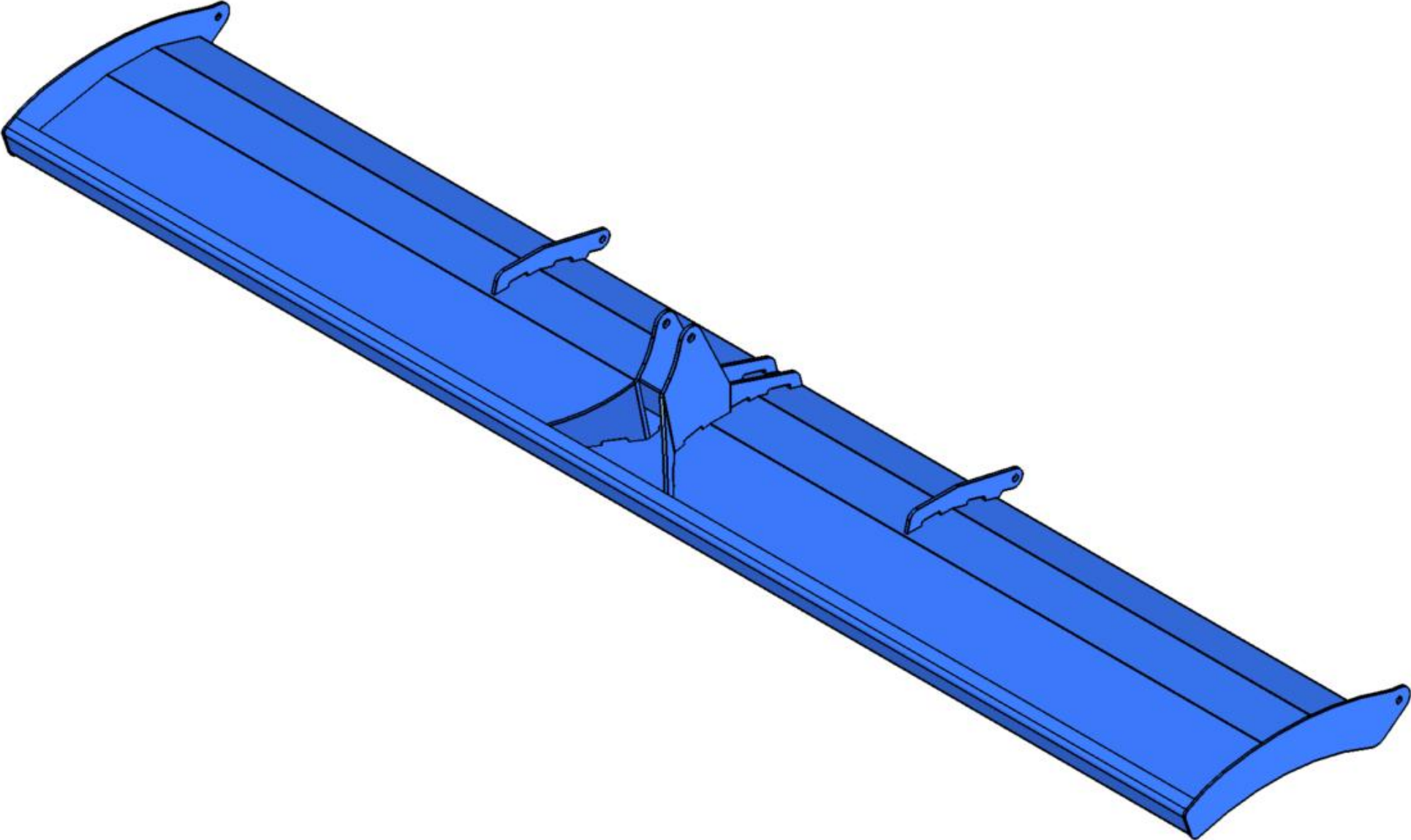

PART NO: P001.341

MS700/MS1000 FRONT VIEW

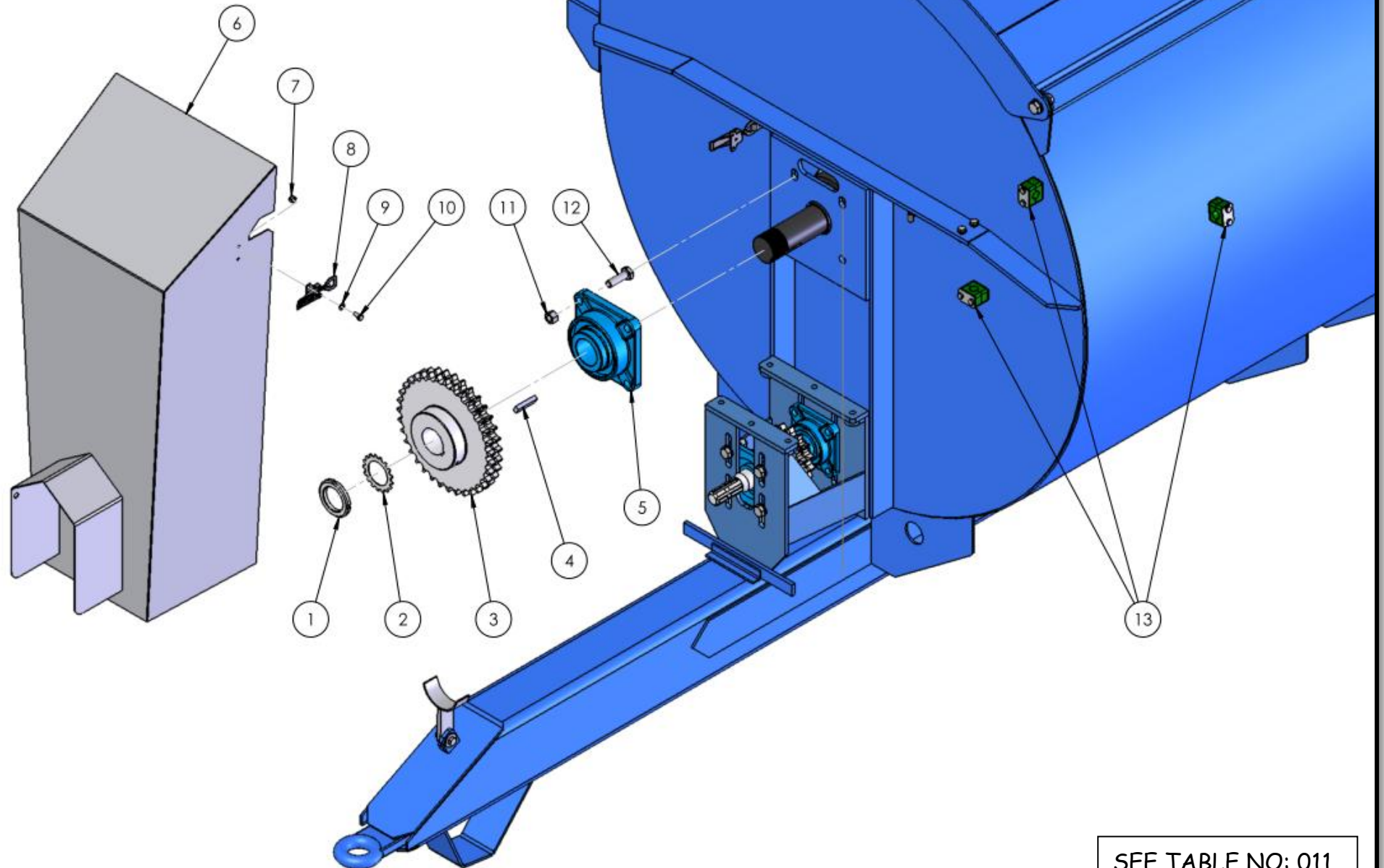

SEE TABLE NO: 011

TABLE NO: 011 M700/MS1000 SIDE SPREADER FRONT VIEW

ITEM NO	DESCRIPTION	MS700		MS1000	
		CODE	QTY	CODE	QTY
1	LOCK NUT	ZFAS77	1	ZFAS94	1
2	TAB WASHER	ZFAS78	1	ZFAS95	1
3	SPROCKET	ZDRI01	1	ZDRI03	1
4	KEYWAY	P001.317A	1	P001.317B	1
5	BEARING	ZDRI09	1	ZDRI08	1
6	GEARBOX COVER	P001.342	1	P001.343	1
7	M5 NYLOCK NUT ZP	ZFAS114	4	ZFAS114	4
8	LATCH	ZGPP211	2	ZGPP211	2
9	M5 WASHER ZP	ZFAS113	4	ZFAS113	4
10	M5X20 SET SCREW ZP	ZFAS112	4	ZFAS112	4
11	M16 NYLOCK NUT ZP	ZFAS23	4	ZFAS23	4
12	M16X55 SET SCREW ZP	ZFAS62	4	ZFAS62	4
13	3/8" SINGLE HOSE HOLDER	ZHYD16	3	ZHYD16	3

MS700/MS1000 REAR VIEW

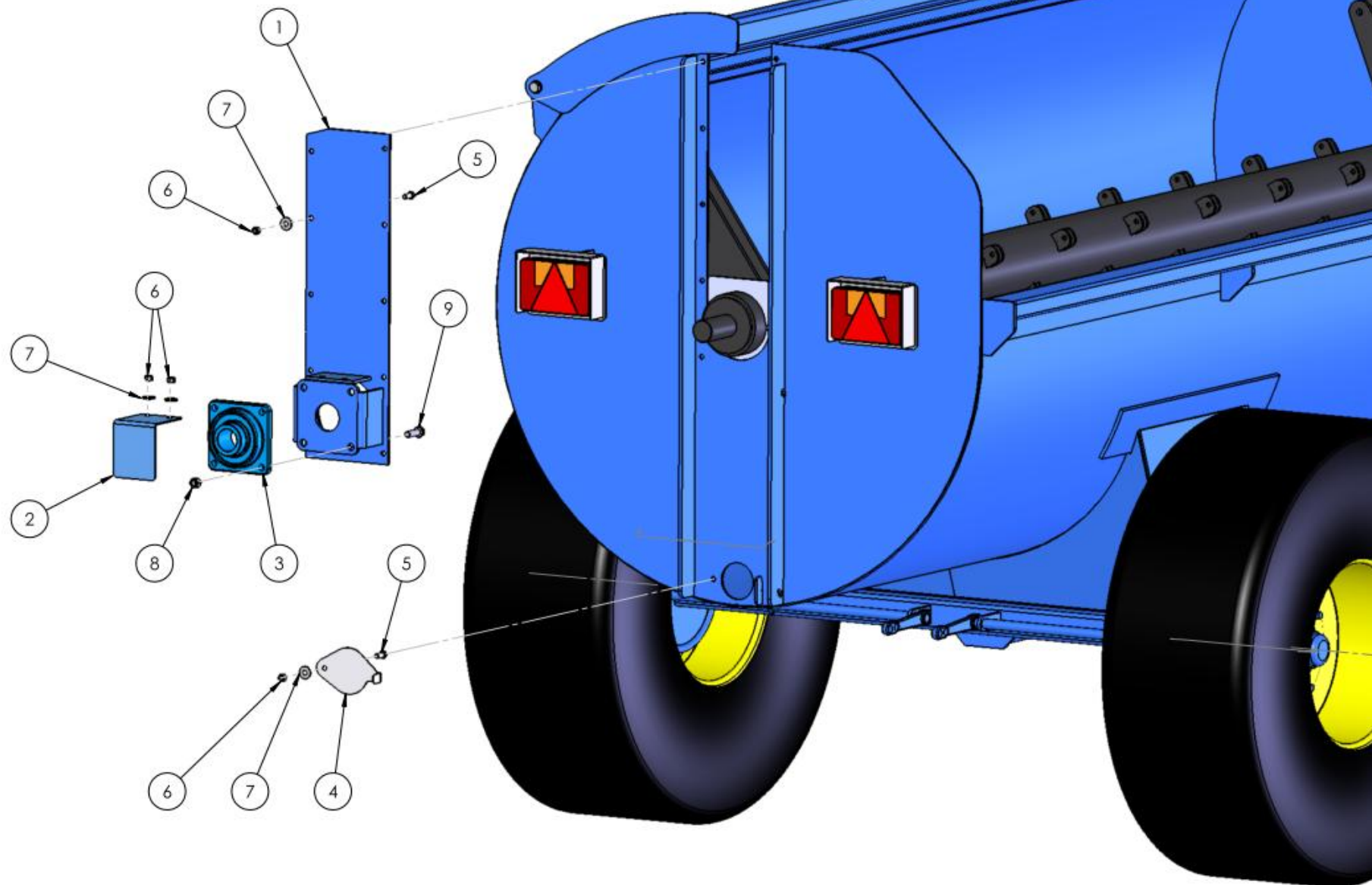

SEE TABLE NO: 012

TABLE NO: 012 M700/MS1000 SIDE SPREADER REAR VIEW

ITEM NO	DESCRIPTION	MS700		MS1000	
		CODE	QTY	CODE	QTY
1	BEARING SUPPORT PLATE	P001.344	1	P001.345	1
2	BEARING COVER	P001.346	1	P001.346	1
3	BEARING	ZDRI10	1	ZDRI09	1
4	DRAIN COVER	P001.325	1	P001.325	1
5	M12X30 SET SCREW ZP	ZFAS10	11	ZFAS10	11
6	M12 NYLOCK	ZFAS23	11	ZFAS23	11
7	M12 WASHER ZP	ZFAS45	11	ZFAS45	11
8	M16 NYLOCK NUT	ZFAS23	4	ZFAS23	4
9	M16X55 SET SCREW ZP	ZFAS62	4	ZFAS62	4

MS700/MS1000 LIGHTS DIAGRAM

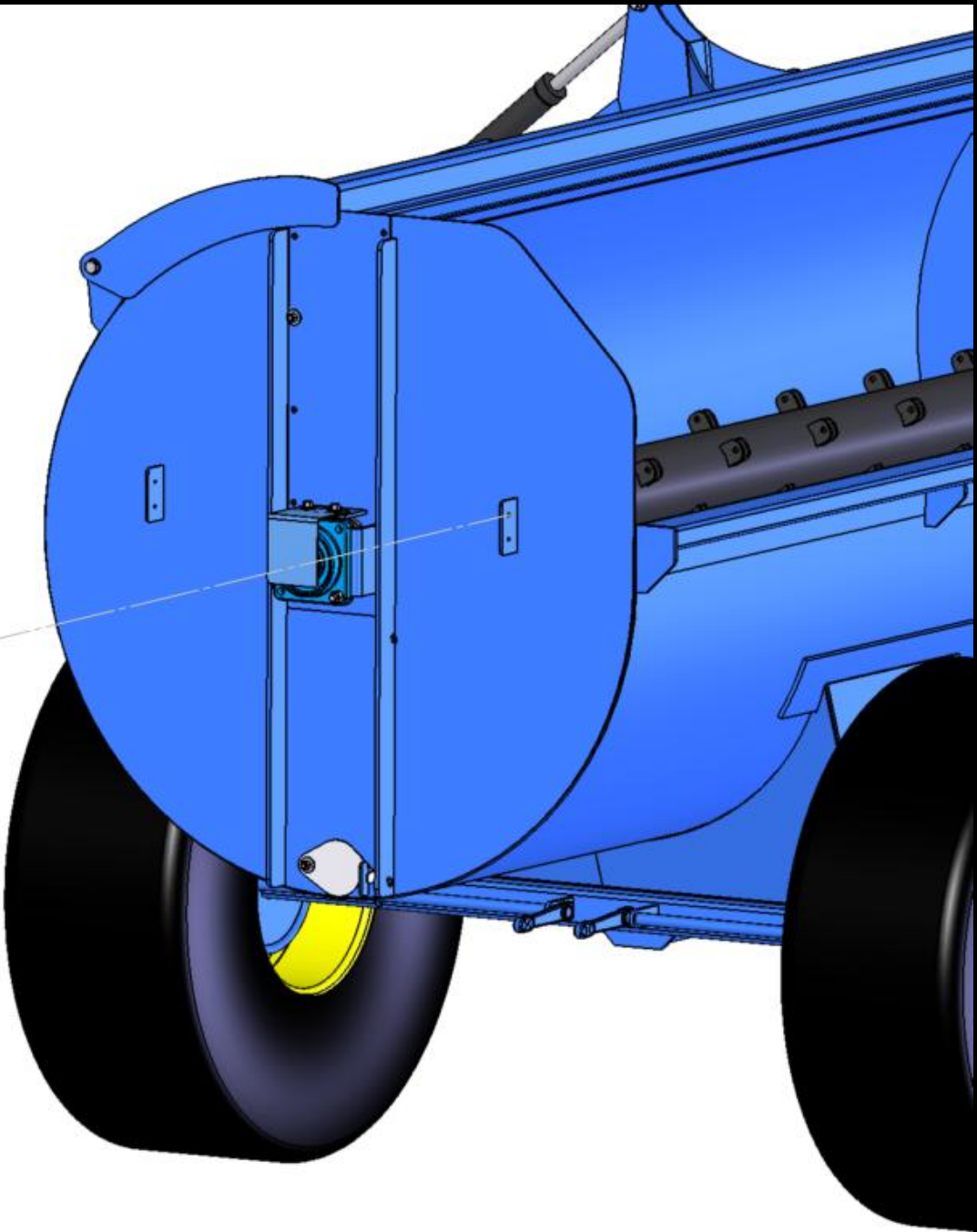
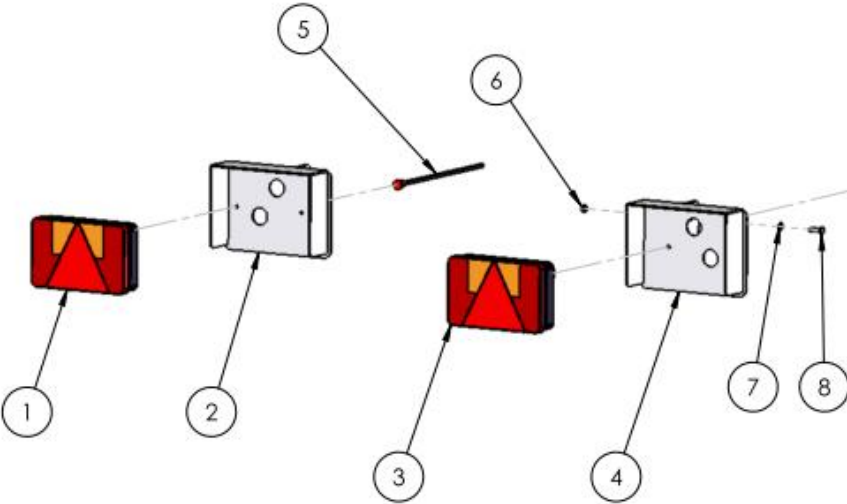

SEE TABLE NO: 013

TABLE NO: 013 M700/MS1000 SIDE SPREADER LIGHTS DIAGRAM

ITEM NO	DESCRIPTION	MS700		MS1000	
		CODE	QTY	CODE	QTY
1	LHD TAIL LIGHT	ZGPP180	1	ZGPP180	1
2	LHD TAIL LIGHT HOLDER	P001.347	1	P001.347	1
3	RHD TAIL LIGHT	ZGPP181	1	ZGPP181	1
4	RHD TAIL LIGHT HOLDER	P001.348	1	P001.348	1
5	WIRING LOOM	ZGPP179	1	ZGPP179	1
6	M8 NYLOCK ZP	ZFAS55	4	ZFAS55	4
7	M8 WASHER ZP	ZFAS132	4	ZFAS132	4
8	M8X35 SET SCREW ZP	ZFAS103	4	ZFAS103	4

MS700/MS1000 SIDE SPREADER ROTOR ASSEMBLY

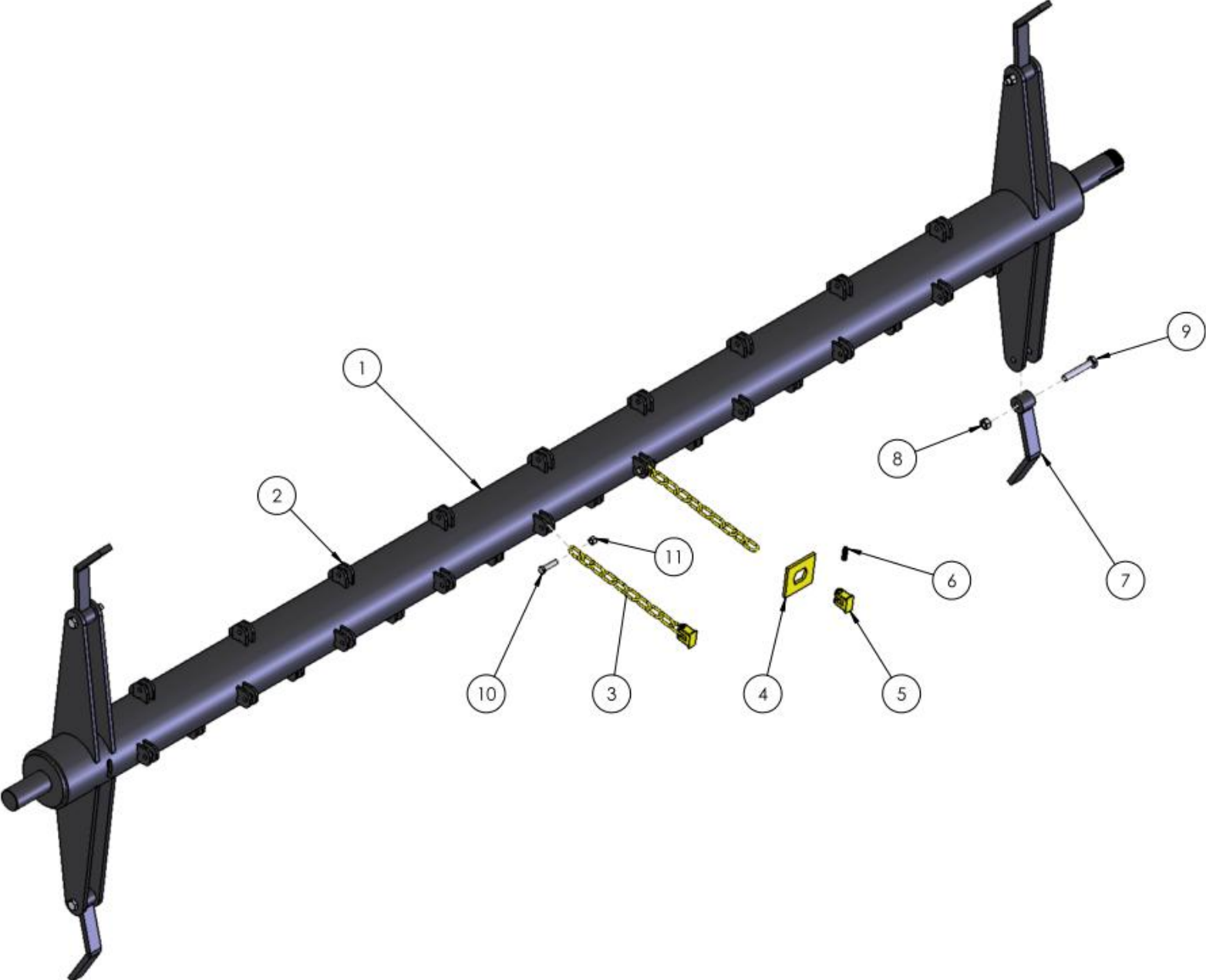

SEE TABLE NO: 014

TABLE NO: 014 M700/MS1000 SIDE SPREADER ROTOR ASSEMBLY

ITEM NO	DESCRIPTION	MS700		MS1000	
		CODE	QTY	CODE	QTY
1	ROTOR	P001.349	1	P001.350	1
2	CHAIN HOLDER	ZPPA248	56	ZPPA311	72
3	MUCK SPREADER CHAIN PLUS WEIGHT	ZGPP122	28	ZGPP129	36
4	MUCKSPREADER PLATE	ZGPP128	28	ZGPP128	36
5	MUCKSPREADER WEIGHT	MSW	28	MSW	36
6	MUCKSPREADER ROLL PIN	MSWP	28	MSWP	36
7	STARTER BAR	P001.351	4	P001.351	4
8	M16 NYLOCK NUT	ZFAS23	4	ZFAS23	4
9	M16X100 BOLT ZP	ZFAS81	4	ZFAS81	4
10	M12X50 BOLT ZP	ZFAS15	28	ZFAS15	36
11	M12 NYLOCK NUT	ZFAS22	28	ZFAS22	36

MS700/MS1000 SIDE SPREADER GEARBOX ASSEMBLY

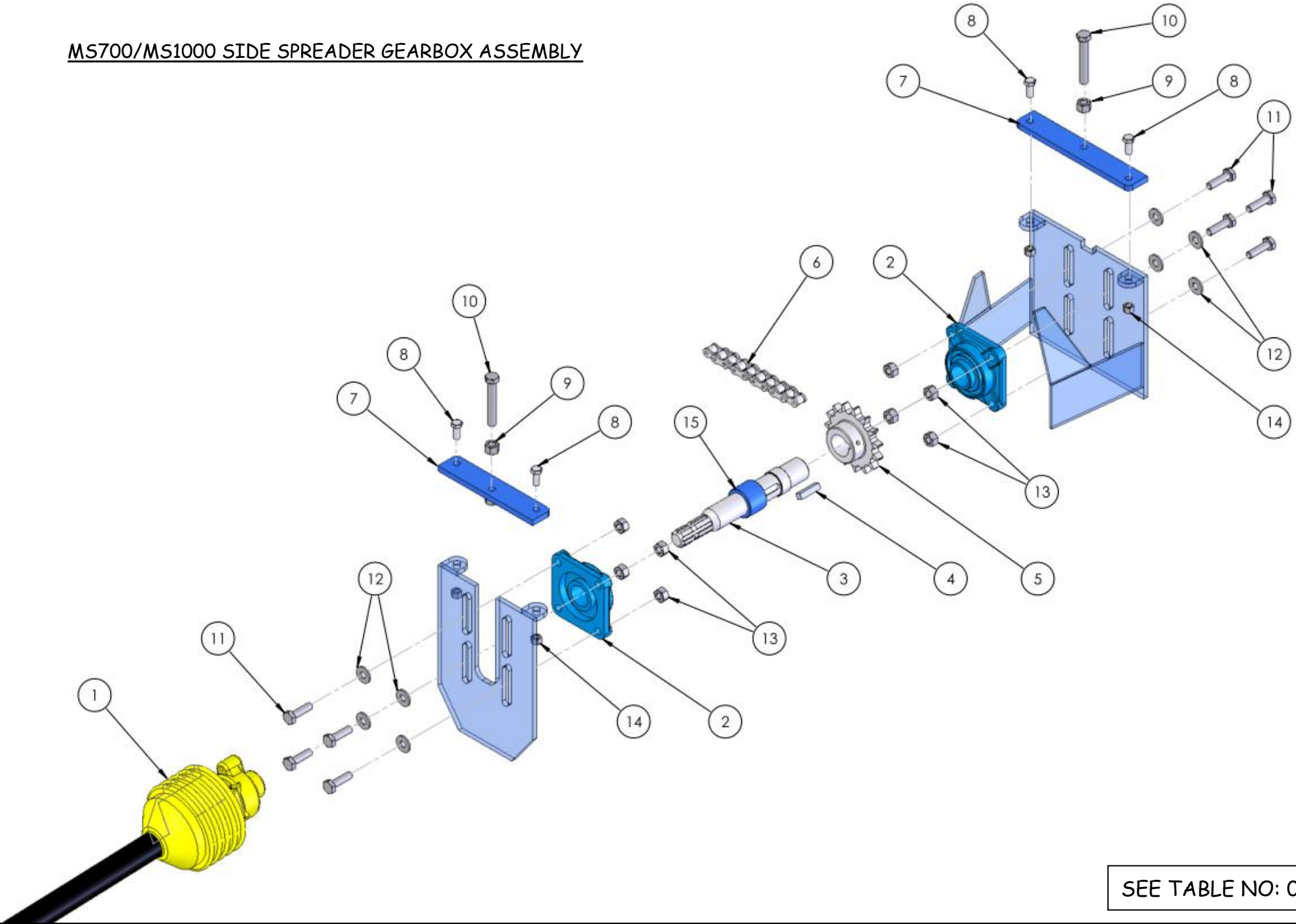

SEE TABLE NO: 015

TABLE NO: 015 M700/MS1000 SIDE SPREADER GEARBOX ASSEMBLY

ITEM NO	DESCRIPTION	MS700		MS1000	
		CODE	QTY	CODE	QTY
1	PTO SHAFT	ZGPP121	1	ZGPP121	1
2	BEARING	ZGPP48	2	ZGPP48	2
3	INPUT SHAFT	ZMAC21	1	ZMAC21	1
4	KEYWAY	P001.333B	1	P001.333C	1
5	INPUT SHAFT COG	ZDRI02	1	ZDRI04A	1
6	DRIVE CHAIN	ZDRI20	1	ZDRI21	1
7	TENSIONER PLATE	P001.334	2	P001.334	2
8	M12X40 SET SCREW ZP	ZFAS51	4	ZFAS51	4
9	M12 PLAIN NUT ZP	ZFAS52	2	ZFAS52	2
10	M12X100 SET SCREW ZP	ZFAS43	2	ZFAS43	2
11	M14X50 BOLT ZP	ZFAS41	8	ZFAS41	8
12	M14 WASHER ZP	ZFAS88	8	ZFAS88	8
13	M14 NYLOCK NUT	ZFAS42	8	ZFAS42	8
14	M12 NYLOCK	ZFAS22	4	ZFAS22	4
15	SPACER	P001.352	1	P001.353	1

MS700/MS1000 SIDE SPREADER BRAKE ASSEMBLY

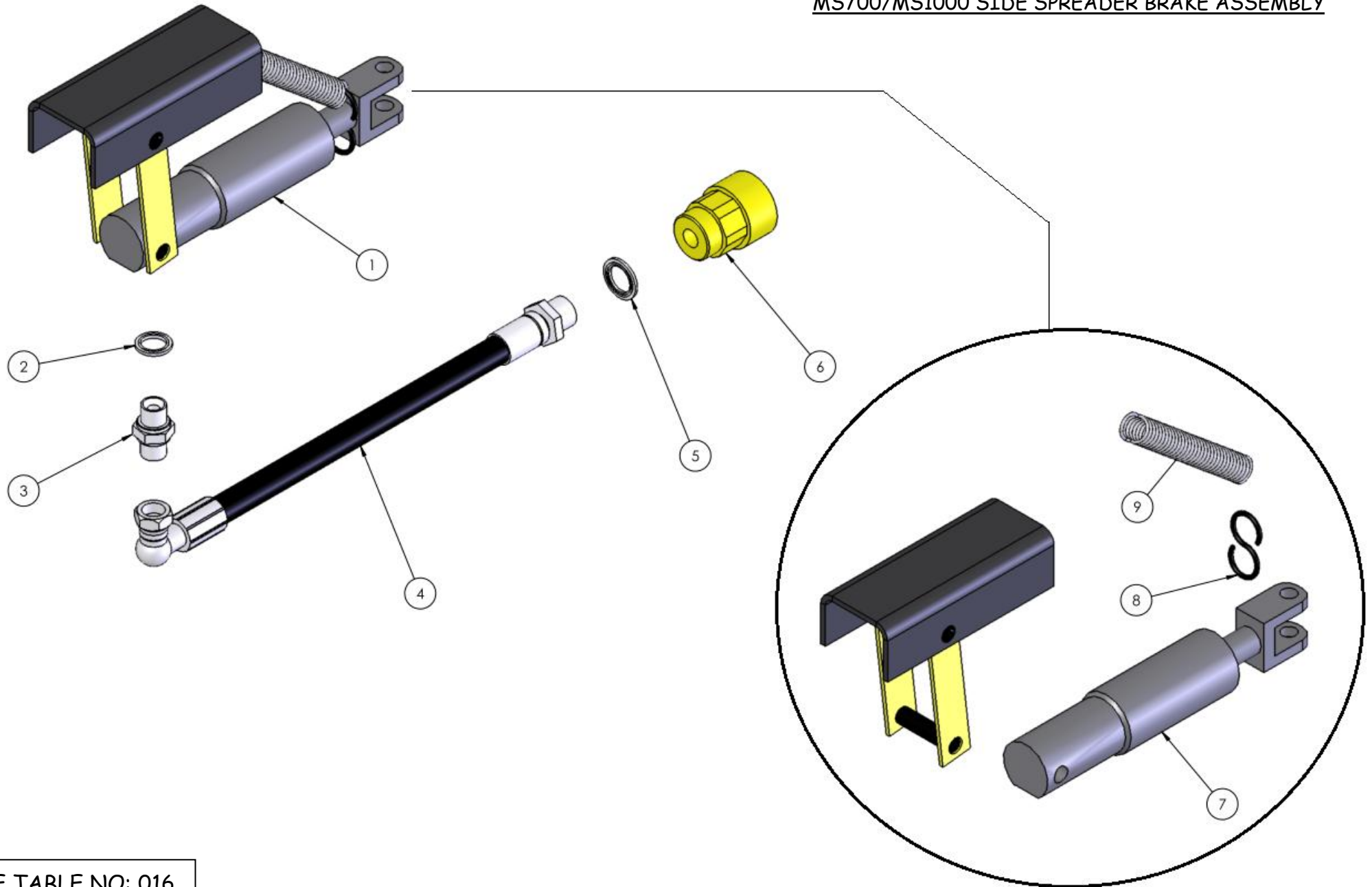

SEE TABLE NO: 016

TABLE NO: 016 M700/MS1000 SIDE SPREADER BRAKE ASSEMBLY

ITEM NO	DESCRIPTION	MS700		MS1000	
		CODE	QTY	CODE	QTY
1	COMPLETE BRAKE ASSEMBLY	ZGPP124	1	ZGPP124	1
2	3/8" DOWDY SEAL	ZHYD05	1	ZHYD05	1
3	3/8" x 3/8" MALE CONNECTOR	ZHYD03	1	ZHYD03	1
4	HYDRAULIC HOSE (Includes Brake fitting)	ZHYD28	1	ZHYD30	1
5	DOWDY SEAL	ZHYD22	1	ZHYD22	1
6	BRAKE COUPLING	ZHYD25	1	ZHYD25	1
7	REPLACEMENT BRAKE CYLINDER	ZGPP73	1	ZGPP73	1
8	S CLIP	P001.354	1	P001.354	1
9	RETURN SPRING	ZSPR11	1	ZSPR11	1

MS700/MS1000 SIDE SPREADER LID HYDRAULIC RAM ASSEMBLY

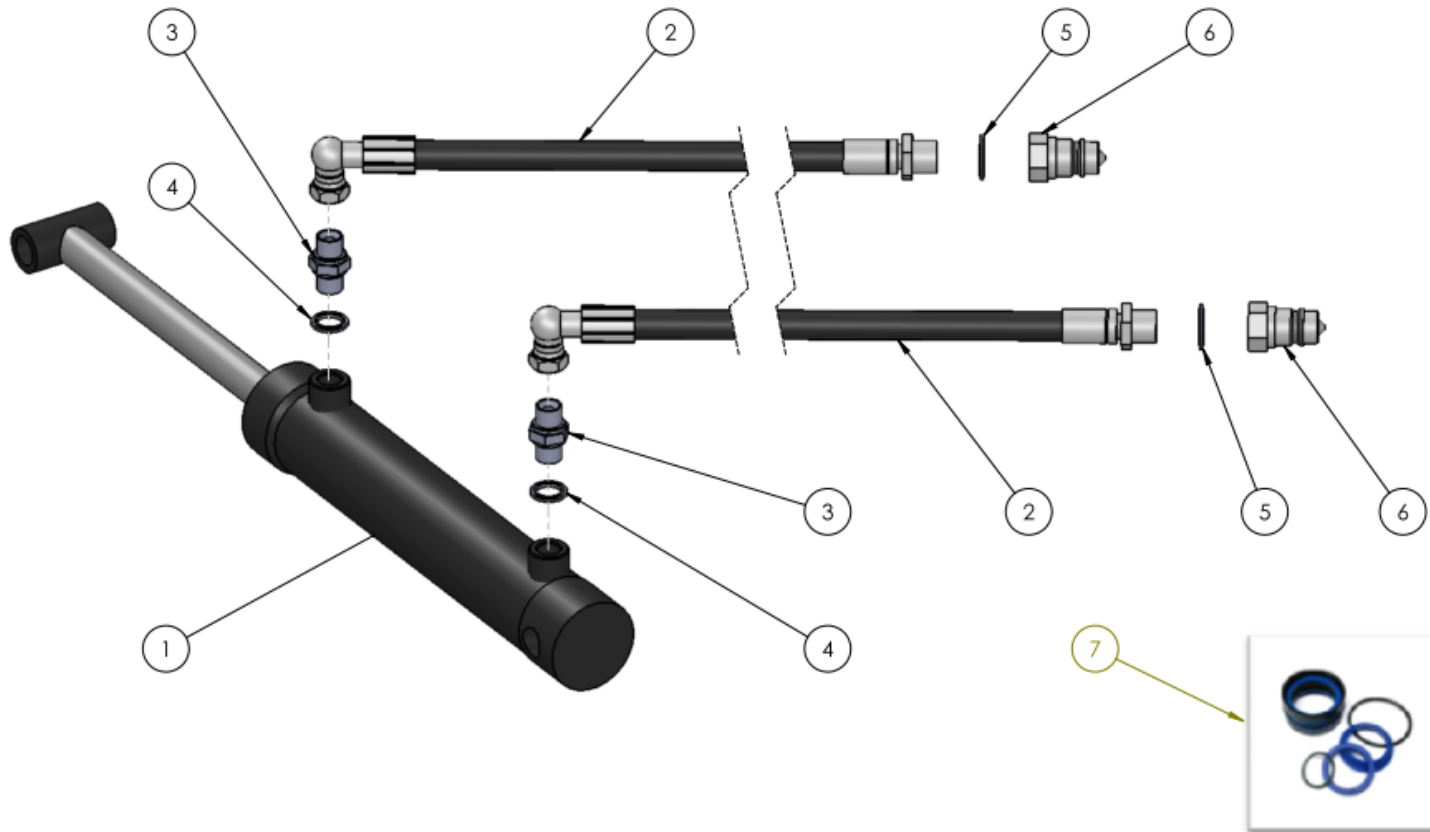

SEE TABLE NO: 017

TABLE NO: 017 M700/MS1000 SIDE SPREADER HYDRAULIC RAM ASSEMBLY

ITEM NO	DESCRIPTION	MS700		MS1000	
		CODE	QTY	CODE	QTY
1	HYDRAULIC CYLINDER	ZHYD17	1		
1	HYDRAULIC CYLINDER MS1000 (2005-2012)			ZHYD17	1
2	HYDRAULIC HOSE	ZHYD18	2	ZHYD11	2
3	3/8" x 3/8" MALE CONNECTOR	ZHYD03	2	ZHYD03	2
4	3/8" DOWDY SEAL	ZHYD05	2	ZHYD05	2
5	DOWDY SEAL	ZHYD22	2	ZHYD22	2
6	½" MALE PROBE	ZHYD26	2	ZHYD26	2
7	HYDRAULIC RAM SEAL KIT	P001.355	1	P001.355	1

MS1000 SIDE SPREADER HYDRAULIC RAM ASSEMBLY 2012 onwards

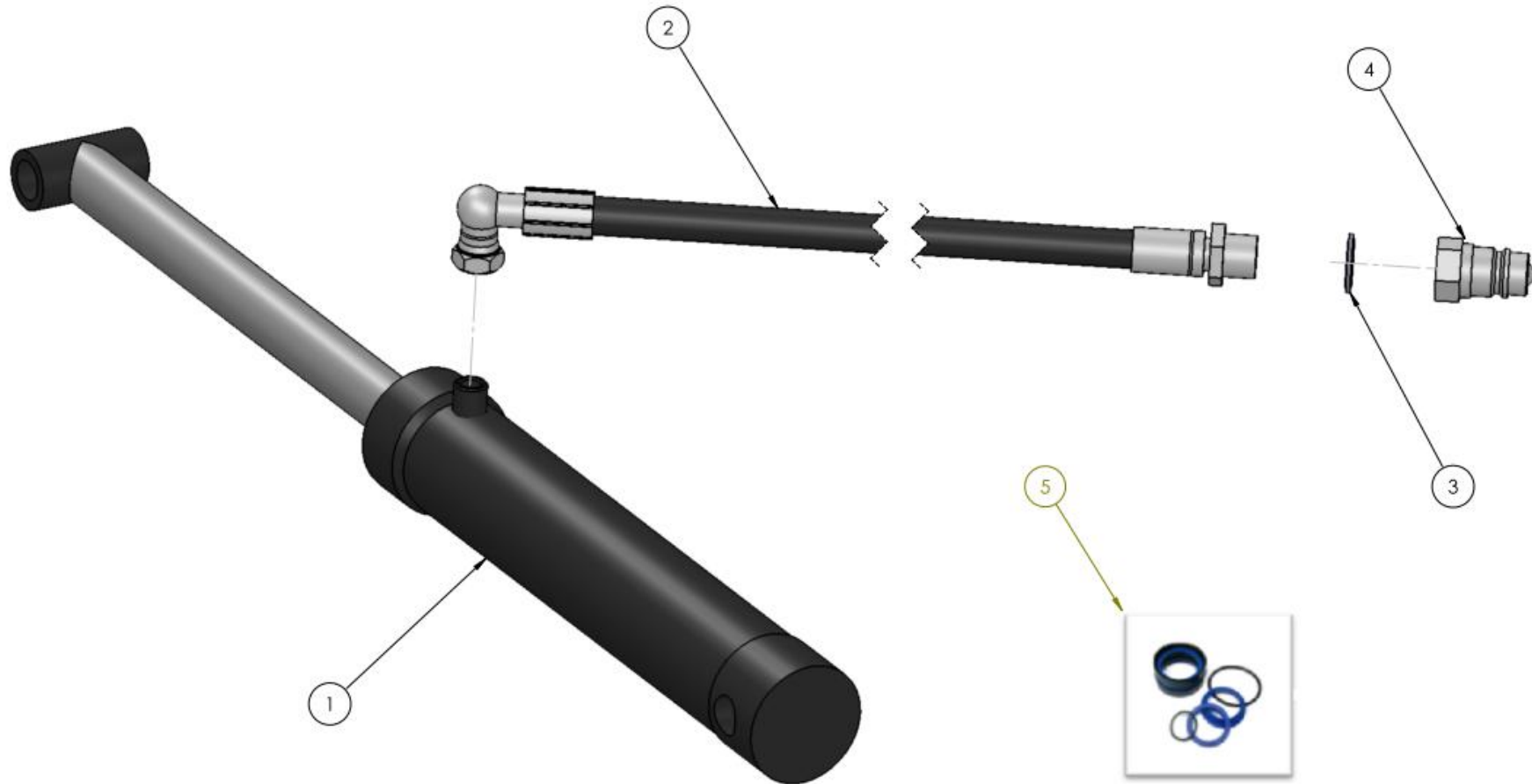

SEE TABLE NO: 018

TABLE NO: 018 MS1000 HYDRAULIC RAM ASSEMBLY (2012 onwards)			
ITEM NO	DESCRIPTION	MS1000	
		CODE	QTY
1	SINGLE ACTING HYDRAULIC RAM	ZHYD17A	1
2	HYDRAULIC HOSE	ZHYD11	1
3	DOWDY SEAL	ZHYD22	1
4	½" MALE PROBE	ZHYD26	1
5	HYDRAULIC RAM SEAL KIT	P001.356	1

MS700 TVZ AXLE Part No: ZGPP120

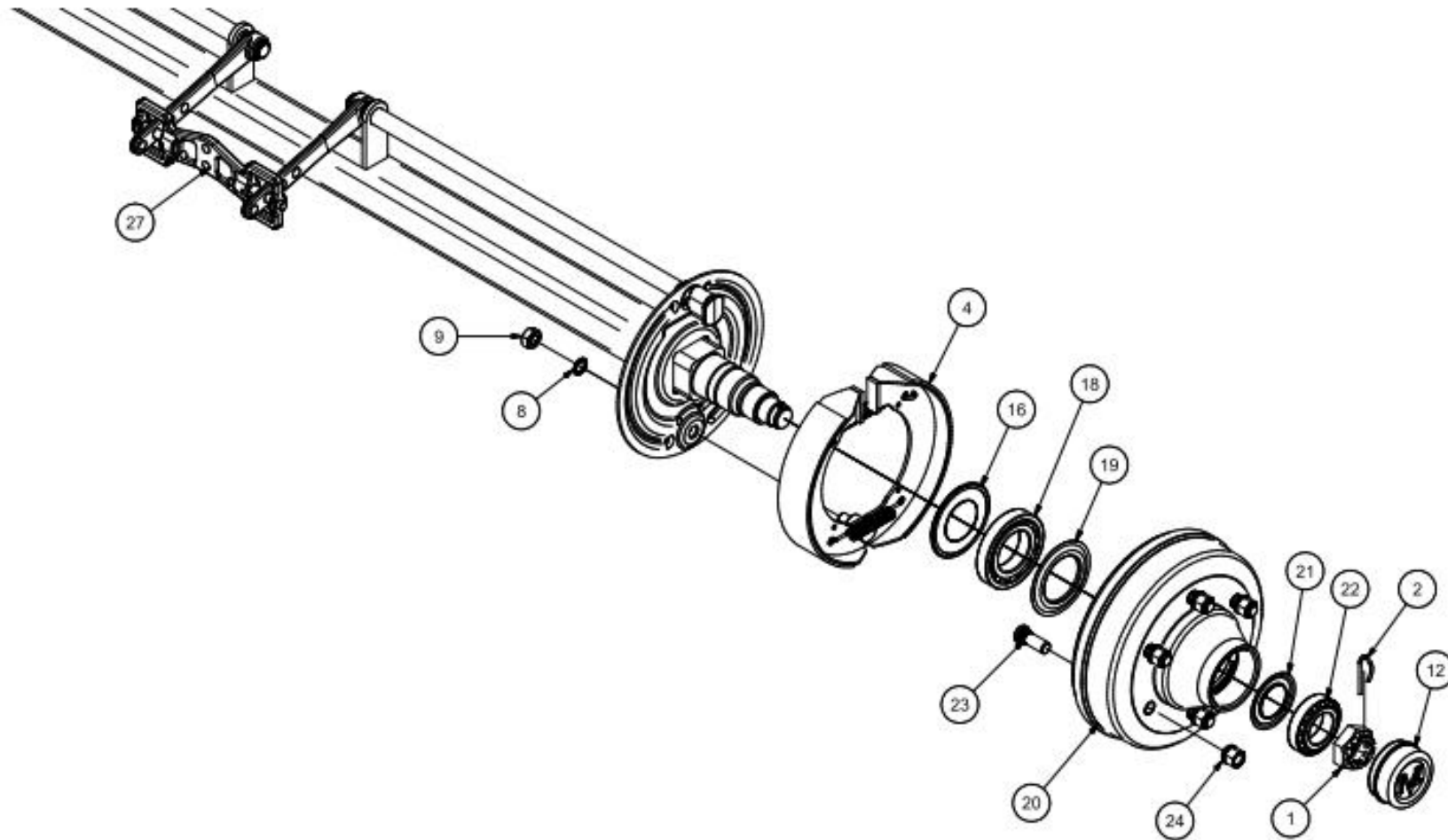

SEE TABLE NO: 019

TABLE NO: 019 MS700 TVZ AXLE Part No: ZGPP120			
ITEM NO	DESCRIPTION	MS700	
		CODE	QTY
1	CROWN NUT M39X1.50	57539B2	2
2	SPRING PIN FOR NUT	58205	2
4	BRAKE SHOE 300X60	9FCA300ZO	2
8	SPRING WASHER D16	915RE16	2
9	NUT M16X2.00	97116D1	2
12	DUST CAP 90mm	56109009	2
16	SEAL	5411201	2
18	BEARING	59130213	2
19	DUST SHIELD	5511201	2
20	DRUM	65L6NA01	2
21	DUST SHIELD	5510901	2
22	BEARING	59132210	2
23	AXLE STUD 18mmx1.5mm	AX-18501.5	12
24	AXLE NUT 18mmx1.5mm	AX-181.5	12
27	COMPENSATOR	768102	1

MS1000 TVZ AXLE Part No: ZGPP17 (New Version)

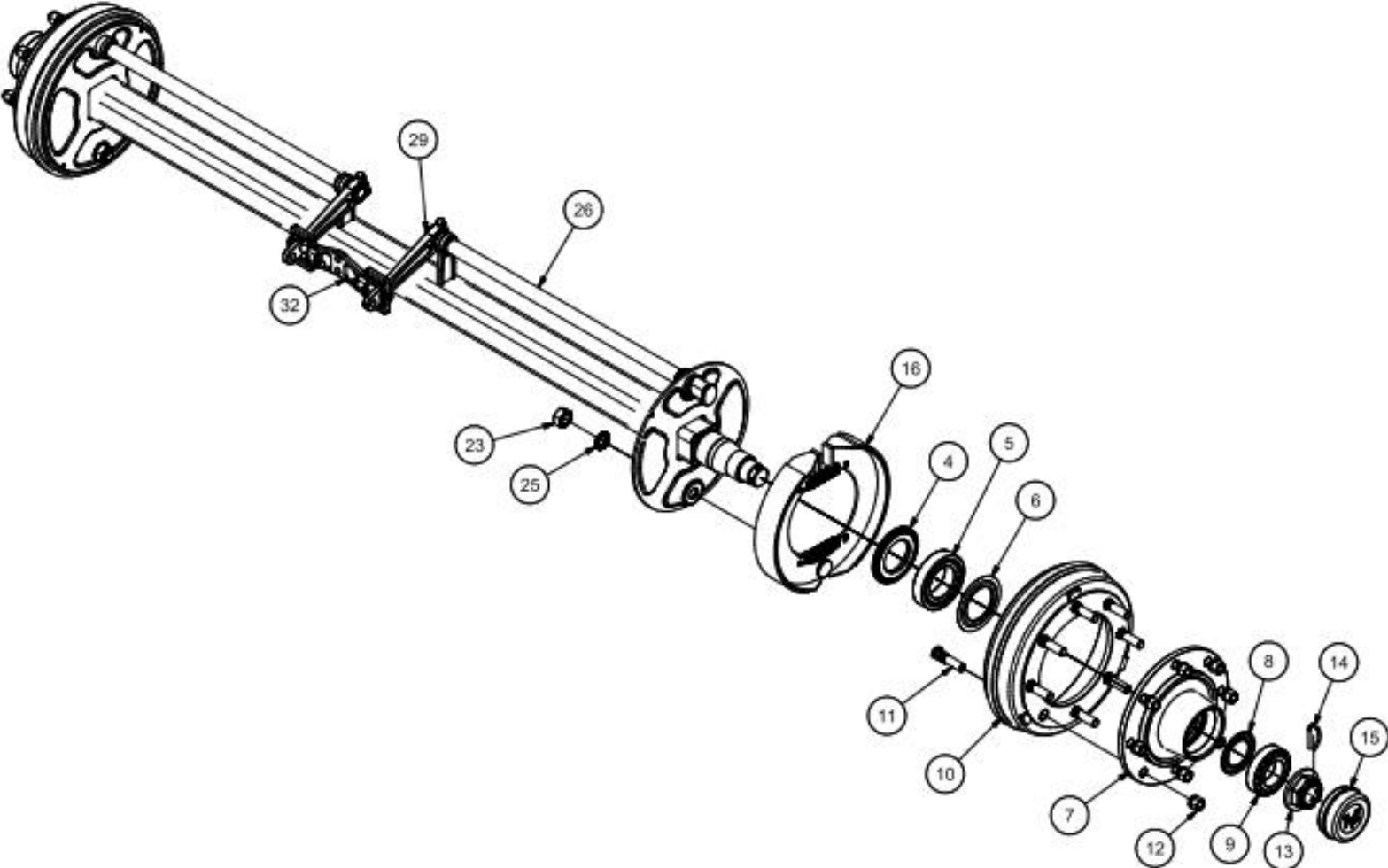

SEE TABLE NO: 020

TABLE NO: 020 MS1000 TVZ AXLE Part No: ZGPP17 (New Version)			
ITEM NO	DESCRIPTION	MS1000	
		CODE	QTY
4	INDUSTRIAL SEAL	5441301	2
5	BEARING	59132215	2
6	DUST SHIELD	5511301	2
7	HUB	61L08110130150	2
8	DUST SHIELD	5530991	2
9	BEARING	59132212	2
10	DRUM	66LNF0803	2
11	AXLE STUD 18mmx1.5mm	AX-18751.5	16
12	AXLE NUT 18mmx1.5mm	AX-181.5	16
13	CROWN NUT M48x1.5	57548B5	2
14	SPRING PIN FOR NUT	58209	2
15	DUST CAP 110mm	56111009	2
16	BRAKE SHOE 350X060	9FCA350ZO	2
23	NUT M24X1.5	97124B1	2
25	TWIN WASHER	9800241	2
26	CAM SHAFT	753032C800	2
29	BRAKE LEVER	7613201	2
32	COMPENSATOR	768102	1

MS1000 TVZ AXLE Part No: ZGPP17 (Old Version)

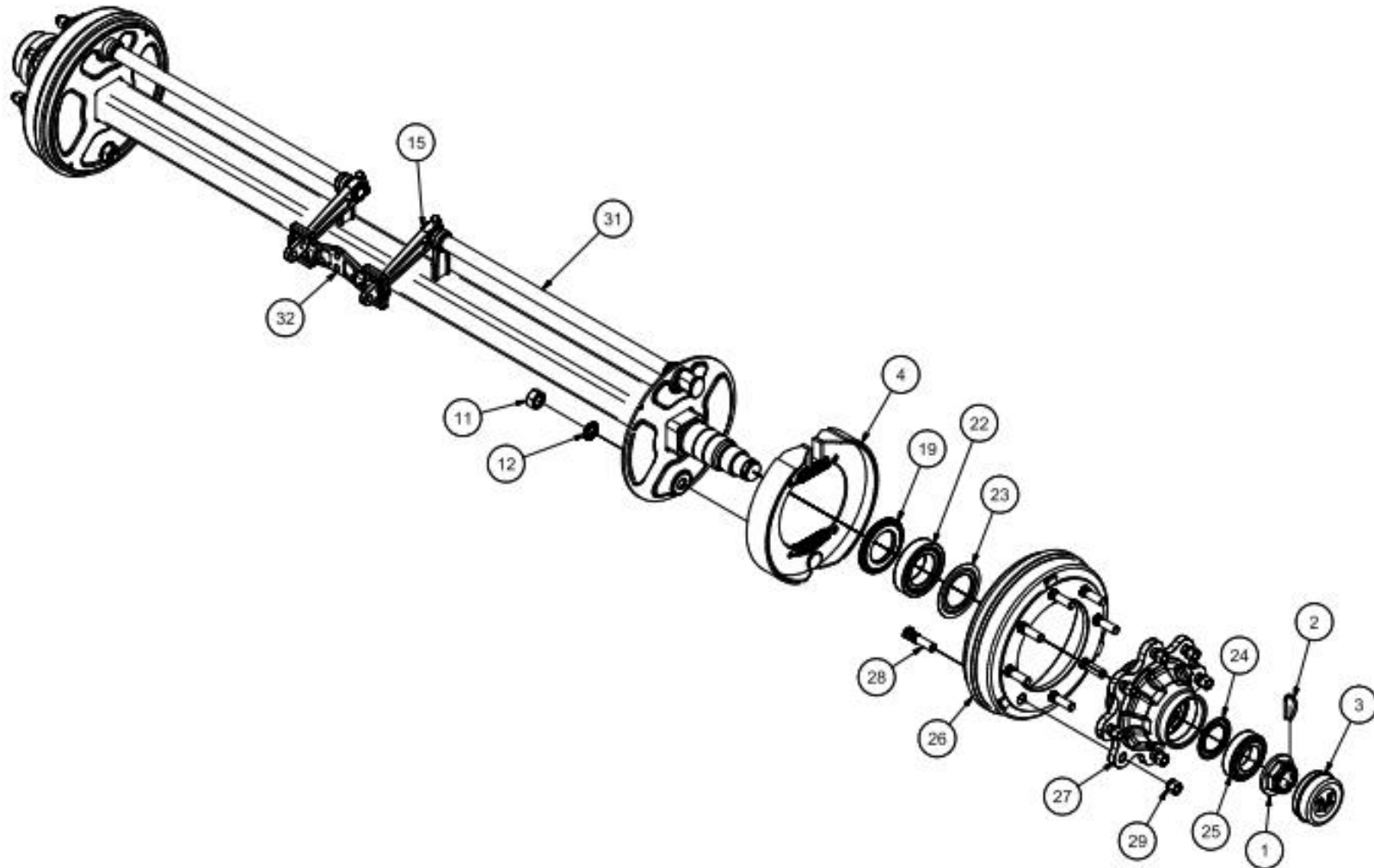

SEE TABLE NO: 021

TABLE NO: 021 MS1000 TVZ AXLE Part No: ZGPP17 (Old Version)			
ITEM NO	DESCRIPTION	MS1000	
		CODE	QTY
1	CROWN NUT M48x1.5	57548B5	2
2	SPRING PIN FOR NUT	58209	2
3	DUST CAP 110mm	56111009	2
4	BRAKE SHOE 350X060	9FCA350ZO	2
11	NUT M24X1.5	97124B1	2
12	TWIN WASHER	9800241	2
15	BRAKE LEVER	7613201	2
19	INDUSTRIAL SEAL	5441301	2
22	BEARING	59132215	2
23	DUST SHIELD	5511301	2
24	DUST SHIELD	5530991	2
25	BEARING	59132212	2
26	DRUM	66LNF0803	2
27	HUB	61L08110130250	2
28	AXLE STUD 18mmx1.5mm	AX-18751.5	16
29	AXLE NUT 18mmx1.5mm	AX-181.5	16
31	CAM SHAFT	753032C800	2
32	COMPENSATOR	768102	1

MS700/1000 SIDE SPREADER PTO SHAFT ZGPP121

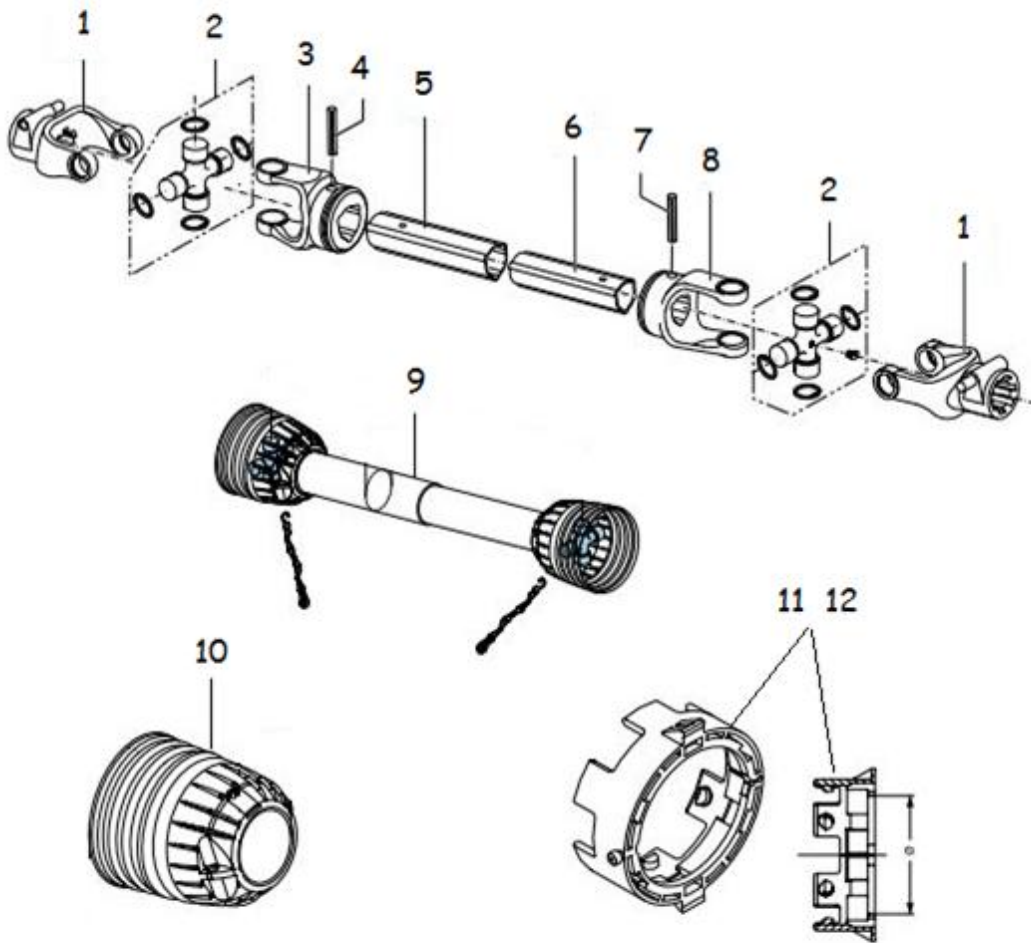

SEE TABLE NO: 022

TABLE NO: 022 MS700/1000 SIDE SPREADER PTO SHAFT

ZGPP121			
POS.	PART NO.	PCS.	DESCRIPTION:
1	P68C-141-026-544	2	1 3/8" x 6 SPLINED YOKE
2	P8C-180-016-130	2	CROSS & BEARING KIT
3	P8C-151-016-028	1	OUTER PROFILE YOKE
4	P8C-190-000-018	1	M10 x 80mm ROLL PIN
5	P8C-152-160-461-0700	1	OUTER PROFILE TUBE 965mm
6	P8C-153-150-334	1	INNER PROFILE TUBE 980mm
7	P8C190-000-016	1	M10 x 70mm ROLL PIN
8	P8C-151-016-029	1	INNER PROFILE YOKE
9	P8C-142-360-016-9650	1	SAFETY COVER
10	P8C-180-036-633	1	SAFETY COVER CONE
11	P9C-180016596	1	(a=69mm) COVER BEARING
12	P9C-180016595	1	(a=60mm) COVER BEARING

MS700/1000 SIDE SPREADER PTO SHAFT ZGPP121

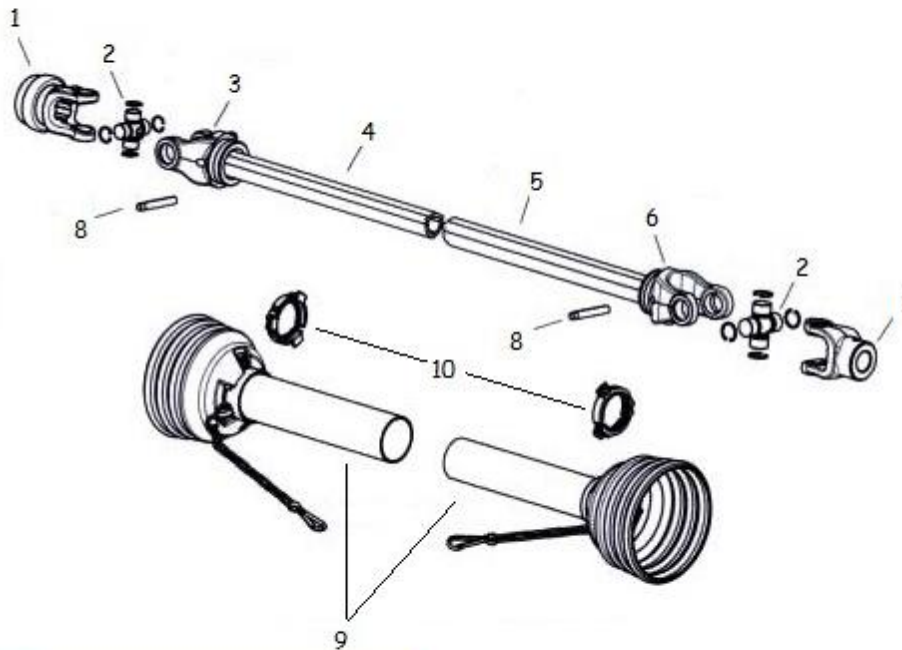

SEE TABLE NO: 023

TABLE NO: 023 MS700/1000 SIDE SPREADER PTO SHAFT			
ZGPP103			
POS.	PART NO.	PCS.	DESCRIPTION:
1	P9T-102-6706	2	1 3/8" x 6 SPLINED YOKE
2	P9T-200-6794	2	CROSS & BEARING KIT
3	P9T-300-6745	1	INNER PROFILE YOKE
4	P9T-610-4504-000	1	INNER PROFILE TUBE 3m
5	P9T-610-5404-000	1	OUTER PROFILE TUBE 3m
6	P9T-300-6754	1	OUTER PROFILE YOKE
8	P9T-508-1085	1	M10 x 85mm ROLL PIN
9	P9T-907-3500-151	1	SAFETY COVER
10	P9T-961-3567	1	SAFETY COVER BEARING KIT